



DEPARTMENT OF COMMUNITY DEVELOPMENT SERVICES

Planning Division

m e m o r a n d u m

TO: Urbana Plan Commission

FROM: Rebecca Bird, Interim Planning Manager

DATE: November 15, 2013

SUBJECT: Plan Case 2218-PUD-13 & Plan Case 2219-PUD-13: 704 E Windsor Road, A request by Gary Olsen on behalf of Verdant Prairies, LLC for preliminary and final approval for a Residential Planned Unit Development.

Introduction

Gary Olsen, on behalf of Verdant Prairies LLC, has submitted an application for preliminary and final approval for a residential planned unit development (PUD) per Section XIII-3 of the Urbana Zoning Ordinance for a 4.01-acre parcel at 704 E. Windsor Road. Application approval would allow construction of 15 one-story attached townhouse units, 16 two-story attached townhouse units and a three-story 15-unit apartment building. The applicant is simultaneously applying for preliminary subdivision approval for Verdant Prairies Villages Subdivision.

The subject property, site of the former Windsor Swim Club, is located northeast of the intersection of South Anderson Street and East Windsor Road and totals 174,691 square feet in area. The property is zoned R-3, Single and Two-Family Residential and has been vacant since 2009 when the Windsor Swim Club closed. The property is now owned by Verdant Prairies LLC. A PUD was approved for this site in 2012, Ordinance No. 2012-04-035. The applicant has substantially revised the site plan, requiring new PUD approvals.

Per Section XIII-3 of the Urbana Zoning Ordinance, review of a proposed PUD requires review and approval of both a Preliminary and Final PUD. Although not dictated by ordinance, review is typically processed as separate applications considered sequentially by the Plan Commission and City Council. In this case, the applicant is refreshing a previously approved Final PUD, meaning that the design concept is already well established. Based on the facts specific to this case, City staff is recommending consideration of both the Preliminary and Final PUD applications concurrently. The Preliminary Subdivision Plat is also being considered concurrently.

Background

Description of Proposed Project

The applicant is proposing to construct Verdant Prairies Village, a residential planned unit development, on the subject site. The proposal allows for a maximum of 46 dwelling units, consisting of three one-story fiveplexes, 16 attached two-story row houses, and one four-story 15-unit apartment building. The fiveplexes and the row houses would be individually owned zero lot line properties and the apartment building would provide 15 rental units. The site will be accessed from Windsor Road with a cul-de-sac, which will be dedicated as a public street. A five-foot wide sidewalk will be provided all along the exterior of the site, connecting to public sidewalks in the northwest corner of the site and along Windsor Road. The sidewalk will also connect to the interior of the site on the east and west property lines. The proposal includes 130 parking spaces, provided in private garages and surface spaces. If all 46 units are built, this would allow two spaces per unit with an additional 38 spaces for guests. A total of 42 bicycle parking spaces will be provided over three locations for the apartment building and the rowhouses. The proposal includes a dry detention basin to manage storm water. Street lighting will primarily be low wattage, focused downward to avoid light intrusion. General and landscaping lighting will be primarily low wattage LEDs, including at entry doors and garages. The project, if approved, would be developed in phases, based on market demand.

According to Table V-I, Table of Uses in the Urbana Zoning Ordinance, a residential planned unit development is allowed in the R-3, Single and Two-Family Residential Zoning District, subject to the regulations and procedures specified in Article XIII of the Urbana Zoning Ordinance.

Previous PUD Approvals

Plan Case 2146-PUD-11 (Preliminary PUD Approval) & 2146-M-11 (Rezoning)

This case consists of a rezoning application and a preliminary PUD application. The subject site was formerly the Windsor Swim Club and was zoned CRE, Conservation, Education, Recreation. The applicant requested a rezoning to R-3, Single and Two-Family Residential and preliminary PUD approval for a residential planned unit development with a maximum of 48 condominiums, consisting of up to one single-family residence, three duplexes, four fourplexes, and two twelve-unit condominium buildings, as well as a club house . Both the rezoning request and the preliminary development plan were approved by City Council on June 20, 2011 by Ordinance Nos. 2011-06-056 and 2011-06-057.

Plan Case 2172-PUD-12 (Final PUD Approval)

This case was a final PUD application for the project described under Plan Case 2146-PUD-11. The approval was passed by City Council on April 2, 2012. Final PUD approval for the residential planned unit development was granted with a waiver for maximum building height. (Ordinance No.2012-04-035 attached, Exhibit F).

Comparison with Previous Approvals

The current proposal is similar to the preliminary and final development plans approved in 2011 and 2012 which included up to 48 condominiums, consisting of up to one single-family residence, three duplexes, four fourplexes, and two twelve-unit condominium buildings, as well as a club house. The primary difference between the earlier approvals and the current applications is that the earlier plan was based on the construction of condominiums, whereas the current plan is for 31 zero-lot-line

townhouses and one 15-unit rental apartment building. The reason the applicant is requesting these revisions is due to difficulties securing funding for construction of condominiums. One of the results of the 2008 housing crisis is that financing has become much more difficult for condominium development. Because of this, the applicant has revised the development plan from all condominiums to 31 zero-lot-line single-family homes and 15 rental apartment units. The revisions will allow the project to move forward with construction.

Adjacent Land Uses, Zoning and Comprehensive Plan Designations

The subject property has frontage on Windsor Road east of Anderson Street. The area to the north, east, and west of the property is residential in nature, with both single family residences and duplexes. The zoning in the surrounding area is mainly R-3, Single and Two-Family Residential, although directly north of the subject property are five lots zoned R-2, Single-Family Residential. The Urbana corporate limits run along the south side of Windsor Road, adjacent to the subject property. The parcel to the south of the subject property is zoned Champaign County AG-2, Agriculture and is used for agricultural purposes.

Following is a summary of zoning and land uses for the subject site and surrounding property. In addition, Exhibits A, B and C further illustrate this information.

Location	Existing Zoning	Existing Land Use	Comprehensive Plan Future Land Use
Site	R-3, Single & Two-Family Residential	Vacant	Residential – Suburban Pattern
North	R-2, Single-Family Residential R-3, Single & Two-Family Residential	Single-Family Dwellings	Residential – Suburban Pattern
South	Champaign County AG-2, Agriculture	Agriculture	Mixed Residential – Suburban Pattern
East	R-3, Single & Two-Family Residential	Single-Family Dwellings Duplexes	Residential – Suburban Pattern
West	R-3, Single & Two-Family Residential	Duplexes	Residential – Suburban Pattern

Comprehensive Plan

The Comprehensive Plan designations for the subject site and the surrounding properties are consistent with the zoning and land use in this area in that the subject site and the neighborhood to the north, east, and west are designated as “Residential – Suburban Pattern.” The Comprehensive Plan defines “Residential – Suburban Pattern” as follows:

Residential areas contain primarily single-family residential housing but may also include a variety of compatible land uses such as duplexes, town homes, civic uses, institutional uses, and parks where zoning is appropriate. Residential areas can have different physical patterns of development:

Suburban Pattern of Development

A pattern of development that is typically found in newer, developing neighborhoods. The development pattern encourages a connected street network with pedestrian and bicycle facilities to serve adjoining neighborhoods, schools, parks and business centers. Cul-de-sacs

should be minimized but may be appropriate where physical features prohibit a connected street system. Lots are typically larger than those found in the urban pattern of development.

The area to the south of the subject site is designated as “Mixed Residential – Suburban Pattern” in the Comprehensive Plan. The notation for this area in Future Land Use Map #14 (Exhibit C) states the following: ‘Condos, Apartments, and Zero-lot line development designed around park and businesses; denser development along Windsor Road.’

The following Comprehensive Plan Goals and Objectives support the proposed residential planned unit development:

Goal 2.0 New development in an established neighborhood will be compatible with the overall urban design and fabric of that neighborhood.

Objectives

- 2.1 Ensure that the site design for new development in established neighborhoods is compatible with the built fabric of that neighborhood.
- 2.2 Encourage the use of landscape materials and ornamentation to improve the appearance and functionality of new developments.
- 2.3 Use development and planning controls to minimize environmental and property damage from flooding and erosion.
- 2.4 Promote development that residents and visitors recognize as being of high quality and aesthetically pleasing.

Goal 3.0 New development should be consistent with Urbana’s unique character.

Objectives

- 3.1 Encourage an urban design for new development that will complement and enhance its surroundings.
- 3.2 Promote new developments that are unique and capture a “sense of place.”

Goal 4.0 Promote a balanced and compatible mix of land uses that will help create long-term, viable neighborhoods.

Objectives

- 4.1 Encourage a variety of land uses to meet the needs of a diverse community.
- 4.3 Encourage development patterns that offer the efficiencies of density and a mix of uses.

Goal 5.0 Ensure that land use patterns conserve energy.

Objectives

- 5.2 Promote building construction and site design that incorporates innovative and effective techniques in energy conservation.

Goal 6.0 Preserve natural resources (including air, water, and land) and environmentally sensitive areas in the community.

Objectives

- 6.1 Protect groundwater and surface water sources from flood and storm-related pollution.

Goal 13.0 Capitalize on Urbana’s unique heritage as a community with a mix of urban and small-town features.

Objectives

- 13.4 Promote the beautification of Urbana through both public and private developments.

Goal 14.0 Increase Urbana’s inventory of trees.

Objectives

- 14.2 Promote appropriate tree plantings in new development to contribute to the urban forest.

Goal 15.0 Encourage compact, contiguous and sustainable growth patterns.

Objectives

- 15.1 Plan for new growth and development to be contiguous to existing development where possible in order to avoid “leapfrog” development.

Goal 16.0 Ensure that new land uses are compatible with and enhance the existing community.

Objectives

- 16.3 Encourage development in locations that can be served with existing or easily extended infrastructure and city services.

Goal 17.0 Minimize incompatible land uses.

Objectives

- 17.1 Establish logical locations for land use types and mixes, minimizing potentially incompatible interfaces, such as industrial uses near residential areas.
- 17.2 Where land use incompatibilities exist, promote development and design controls to minimize concerns.

Goal 18.0 Promote infill development.

Objectives

- 18.1 Promote the redevelopment of underutilized property using techniques such as tax increment financing, redevelopment loans/grants, enterprise zone benefits, marketing strategies, zoning incentives, etc.

Goal 19.0 Provide a strong housing supply to meet the needs of a diverse and growing community.

Objectives

- 19.1 Ensure that new residential development has sufficient recreation and open space, public utilities, public services, and access to commercial and employment centers.
- 19.2 Encourage residential developments that offer a variety of housing types, prices and designs.

Goal 20.0 Encourage the development of new “planned neighborhoods.”

Objectives

- 20.1 Promote a “traditional neighborhood development” style as an alternative to the conventional suburban development pattern.
- 20.2 Encourage new neighborhoods to include a mix of residential types, with convenient access to schools, parks, shopping, work places, services, and transit.
- 20.3 Promote compact and contiguous development of new neighborhoods along the High Cross Road, Windsor Road, and East Airport Road corridors.

Goal 36.0 Protect both developed and undeveloped areas from increases in runoff and localized flooding.

Objectives

- 36.1 Protect life and property from storm and floodwater damage.
- 36.2 Reduce the impacts of development on stormwater conditions through regulations, including appropriate provisions for detention and conveyance.

Discussion

The proposed PUD consists of construction of 15 townhouses in three one-story fiveplexes, 16 attached two-story townhouses, and one 15-unit four-story apartment building, providing a range of housing choices for the market. The townhouses will include two parking spaces each, and the apartment building has 23 parking spaces provided at grade. In addition, the development will include a five-foot wide sidewalk around the perimeter of the site which will connect to a public sidewalk in the northwest corner of the site and along Windsor Road. Development of the site will include elimination of the existing drive off of Windsor Road and construction of a new drive in the western portion of the property line along Windsor Road. The drive will enter the site as a divided roadway and then access a circular one-way cul-de-sac that will provide access to the fiveplexes. The drive and cul-de-sac will be dedicated to the City and become a public street. There will be a privately owned drive to access the row houses with a hammerhead turn-around at the eastern end to accommodate fire engines. The development will feature “green” site design and building construction, in particular modular construction. Although the applicant includes a dry detention basin, a detailed stormwater management plan will need to be submitted as part of the engineering plan approval.

PUD Ordinance Goals

Section XIII-3.C of the Zoning Ordinance outlines nine general goals for planned unit developments as follows:

1. To encourage high quality non-traditional, mixed use, and/or conservation development in areas identified in the Comprehensive Plan;
2. To promote infill development in a manner consistent with the surrounding area;
3. To promote flexibility in subdivision and development design where necessary;
4. To provide public amenities not typically promoted by the Zoning Ordinance;
5. To promote development that is significantly responsive to the goals, objectives, and future land uses of the Urbana Comprehensive Plan;
6. To provide a higher level of street and pedestrian connectivity within the development and the surrounding neighborhood in accordance with the Urbana Comprehensive Plan.
7. To coordinate architectural styles, building forms, and building relationships within the development and the surrounding neighborhood;
8. To encourage the inclusion of a variety of public and private open space, recreational facilities, greenways and trails not typically promoted by the Zoning Ordinance;
9. To conserve, to the greatest extent possible, unique natural and cultural features, environmentally sensitive areas, or historic resources, and to utilize such features in a harmonious fashion.

PUD's are to be reviewed for their consistency with the above general goals. The proposed Verdant Prairies PUD is consistent with goals 1, 2, 3, 5, 6, 7, and 8. The proposed PUD is a high quality, mixed residential infill development that will utilize flexible zoning standards to provide a development that is compatible with the surrounding area. The proposed development is responsive to the Comprehensive Plan as outlined in the following section. A variety of compatible building designs, materials, colors, and architectural styles will unify the overall development. The proposal includes amenities and innovations such as a recreational sidewalk and modular construction.

Applicability

Section XIII-3 of the Urbana Zoning Ordinance outlines requirements for a PUD. A PUD is defined as “a large, integrated development adhering to a detailed site plan and located on a contiguous tract of land that may include a mixture of residential, commercial and/or industrial uses”. Planned unit developments can be residential, commercial, mixed use, or industrial. The proposed Verdant Prairies PUD is a residential PUD. To be considered as a PUD, the proposed development plan must include a gross site area of at least one-half acre and meet at least one of four criteria outlined in Section XIII-3.D of the Zoning Ordinance. The proposed development consists of 4.01 acres and therefore meets the lot size criterion. The proposed Verdant Prairies PUD also meets the criteria listed below as defined by the Urbana Zoning Ordinance. Following each criteria (*provided in italics*) is analysis offered by City staff.

- a) Mixed Use – Either in the same building or with a “campus” layout, provide for a mixture of single-family, two-family, multi-family, commercial, office and/or recreational uses.

The proposed Verdant Prairies PUD presents a plan that will provide a mixture of housing types, including owner-occupied fiveplexes and row houses, and multi-family rental in a “campus” approach. The development will include a recreational walking path for the use of residents.

- b) Conservation – Protect natural, cultural and/or historical resources and harmoniously utilize such features as part of the development. This may include environmentally sensitive or “green” building and site design.

The proposal is for an energy efficient “green” community. It incorporates “green” building and site design features, including “green” construction of the modular units and low wattage lighting. In addition, “green” upgrades will be offered to the owners such as geothermal heating and solar panels.

- c) Infill - Redevelop properties within the urban area that are vacant or underutilized due to obstacles such as lot layout, utility configuration and road access.

The proposal will result in the redevelopment of a property within an urban area that is currently vacant. The proposed PUD consists of a redevelopment plan that is consistent with the surrounding neighborhood and will provide 46 new housing units for the community.

- d) Unique Development – Development that significantly responds to the goals and objectives of the Comprehensive Plan and other relevant plans and policies and/or addresses unique features of the site.

The proposed Verdant Prairies PUD would provide a unique residential development with a mix of housing types, including fiveplexes, row houses, and an apartment building. The residents will have access to shared open space. A sidewalk around the perimeter of the lot will provide recreational opportunities. The specific goals and objectives of the Comprehensive Plan applicable to the proposed PUD are detailed in a previous section.

Permitted Uses

Any agriculture, residential, public/quasi-public, or business use identified in the Zoning Ordinance by Table V-1: Table of Uses, may be permitted in a residential PUD with the exception of those uses listed in Section XIII-3.M. The proposed PUD involves a mixture of residential types, including a five-plexes, attached row houses, and a multi-family building. All of these residence types are listed as residential uses in Table V-1; therefore, the proposed use is permitted.

Minimum Development Standards

Planned unit developments allow developers flexibility in applying zoning and development regulations. The Zoning Ordinance requires that waiver of zoning and development regulations be expressly stated as part of a PUD approval. The petitioner is proposing a variety of waivers for lot dimensions, floor area ration, open space ratio, setbacks, building height, and access drive width. Aside from the items listed below, all other applicable zoning requirements per the Urbana Zoning Ordinance apply.

1. Minimum lot size at 1600 square feet.
2. Average lot width at 17 feet.
3. Maximum floor area ratio shall be as necessary to construct the PUD as presented herein.
4. Minimum open space ratio shall be as necessary to construct the PUD as presented herein.
5. Minimum front yard setback at 1.5 feet for Lot 133 and no less than 7 feet for all other lots.
6. Minimum side yard setback at 1.5 feet for Lot 118.
7. Minimum rear yard setback at 1.5 feet for Lots 118 to 133.
8. The apartment building on lot 101 will have a maximum height of 51 feet 7 inches.
9. Access drives serving single-family homes and duplexes may be allowed to be up to 100% of the total lot width.
10. Lot 118 will be provided with a permanent easement for two parking spaces in Lot 117, as shown on the preliminary plat.

Although a waiver is not required for increased density, it is important to note that the proposed development has a higher density than is generally allowed in the R-3 zoning district, but that this density is consistent with the earlier PUD approvals.

Criteria for Approval

According to Section XIII-3 of the Urbana Zoning Ordinance, the Plan Commission shall determine whether the reasons outlined in the submitted application and the evidence adduced during the public hearing, justify approval based on the following criteria. (Please see Exhibits D and E for the petitioner's specific response to each question.)

- 1. That the proposed development is conducive to the public convenience at that location.*

The proposed project would be an infill development surrounded on three sides by a mature residential neighborhood. The site currently has street access and full utilities. The proposal would provide a

variety of choices for the housing market including five-plexes, attached row houses, and apartments. The requirement that development plans be reviewed and approved for PUD's provides an assurance of how the site will be developed and allows for flexibility in designing a development that will be consistent with the surrounding residential uses.

The current application is a revision to a previously approved residential planned unit development. In 2011 and 2012, preliminary and final development plans were approved for this site with a similar development concept. The petitioner has revised the original development plan due to difficulties attaining funding for a condominium-based plan. The revised development plan is comprised of zero-lot-line single family homes and a rental apartment building, instead of all condominiums as in the earlier plan. The current proposal consists of 46 dwelling units, instead of the 48 included in the previous approval. However, in order to subdivide the lot to create 35 individual lots, some of the on-site amenities have been lost, such as the clubhouse, rain gardens, and the use of permeable pavement. The configuration of the subdivision does not leave sufficient commons areas to allow construction of a clubhouse and rain gardens, and the permeable pavement is no longer possible as the street will be dedicated to the City and become a public street. Although the proposed development would have benefited from these amenities, the current proposal does retain the walking path around the perimeter of the site, low-wattage LED lighting, and landscaped commons areas. The proposal is conducive to the public convenience at this location as it will redevelop a vacant lot that is in the urbanized area and is well connected to public utilities and transportation systems, and will expand the housing types available to the community.

2. *That the proposed development is designed, located, and proposed to be operated so that it will not be unreasonably injurious or detrimental to the surrounding areas, or otherwise injurious or detrimental to the public welfare.*

The proposed development is a residential development on a site that was formerly used as a swim and tennis club. The site is surrounded on three sides by single-family residences and duplexes. Concerns regarding privacy and stormwater management were raised by nearby property owners at the public hearings for the previous PUD approvals and these concerns are reflected in the current site plan. The proposed PUD includes a dry stormwater detention basin and will have to meet City regulations regarding stormwater management. As with the previous approval, the petitioner has stated that he will work individually with adjacent property owners to determine appropriate landscaping and screening treatment when development adjacent to their property occurs and will accommodate owners whenever possible.

The final development plan illustrates elimination of the existing drive off of Windsor Road and construction of a new drive in the western portion of the property line along Windsor Road. The drive will enter the site as a divided roadway and then access a circular one-way cul-de-sac that will provide access to the five-plexes. The drive and cul-de-sac will be dedicated to the City and become a public street. There will be a privately owned drive to access the row houses with a hammerhead turn around at the eastern end to accommodate fire engines.

The PUD has been designed to maximize compatibility with the adjacent properties by providing for a gradation of building heights, with one-story buildings on the northern portion of the site adjacent to existing single-family residences. The buildings would increase in height as you move through the site from north to south, with the tallest buildings along Windsor Road acting as a sound and visual barrier between the interior of the site and Windsor Road. The proposed street layout provides additional protection for adjacent property owners as the street is contained entirely within the site.

The proposed development will not be injurious or detrimental to the surrounding area or to the public welfare. The proposed PUD will be required to meet City regulations regarding lighting, stormwater management, and traffic design and flow.

3. *That the proposed development is consistent with goals, objectives and future land uses of the Urbana Comprehensive Plan and other relevant plans and polices.*

As noted previously, the proposed PUD is responsive to the following goals of the 2005 Urbana Comprehensive Plan:

- Goal 2.0 New development in an established neighborhood will be compatible with the overall urban design and fabric of that neighborhood.
- Goal 3.0 New development should be consistent with Urbana's unique character.
- Goal 4.0 Promote a balanced and compatible mix of land uses that will help create long-term, viable neighborhoods.
- Goal 5.0 Ensure that land use patterns conserve energy.
- Goal 6.0 Preserve natural resources (including air, water, and land) and environmentally sensitive areas in the community.
- Goal 13.0 Capitalize on Urbana's unique heritage as a community with a mix of urban and small-town features.
- Goal 14.0 Increase Urbana's inventory of trees.
- Goal 15.0 Encourage compact, contiguous and sustainable growth patterns.
- Goal 16.0 Ensure that new land uses are compatible with and enhance the existing community.
- Goal 17.0 Minimize incompatible land uses.
- Goal 18.0 Promote infill development.
- Goal 19.0 Provide a strong housing supply to meet the needs of a diverse and growing community.
- Goal 20.0 Encourage the development of new "planned neighborhoods."
- Goal 36.0 Protect both developed and undeveloped areas from increases in runoff and localized flooding.

4. *That the proposed development is consistent with the purpose and goals of Section XIII-3 of the Urbana Zoning Ordinance.*

As noted previously, the proposed Verdant Prairies PUD is consistent with goals 1, 2, 3, 5, 6, 7, and 8 of Section XIII-3 of the Urbana Zoning Ordinance. The proposed PUD is a high quality, mixed use infill development that will utilize flexible zoning standards to provide a development that is compatible with the surrounding area. The proposed development is also responsive to the above-listed goals in the Comprehensive Plan. A variety of compatible building designs, materials, colors, and architectural styles will unify the overall development. The proposal includes amenities and innovations such as landscaped open areas and a recreational sidewalk.

5. *That the proposed development is responsive to the relevant recommended design features identified in Table XIII-2 of the Zoning Ordinance.*

The following design features have been incorporated into the Final Development Plan:

Recommended Design Features

Table XIII-2 of the Urbana Zoning Ordinance (attached as Exhibit G) lists recommended design features for PUD's. One of the criteria for approval of a final development plan is to illustrate how a proposed PUD is responsive to recommended design features. The following design features have been noted by staff as being incorporated in the final development plan:

Transition Area – the buildings on the northern portion of the site and adjacent to existing single-family residences are one-story in height to maximize compatibility with the adjacent properties. The buildings would increase in height as you move through the site from north to south, with the tallest building along Windsor Road acting as a sound and visual barrier between the interior of the site and Windsor Road. In addition, a dry stormwater detention basin is included along the southern portion of the site which will not only provide environmental benefits, but will also serve as a transition between the residences and Windsor Road.

Lighting – the plans specify low-wattage LED lighting.

Street Lighting – street lighting will be coordinated with the City Engineer to maximize safety and visibility while minimizing intrusion into private areas.

Access – there is currently an access drive on the western end of the Windsor Road frontage. The final development plan shows the elimination of this drive and the construction of a new drive in the western portion of the lot along Windsor Road. This will lead to a circular one-way cul-de-sac that will provide access to the five-plexes and the apartment building. The drive and cul-de-sac will be dedicated to the City and become a public street. There will be a privately owned drive to access the row houses with a hammerhead turn around at the eastern end to accommodate fire engines. There is a public sidewalk on Windsor Road along the southern property line of the site. The final development plans include a sidewalk along the west, north, and east property lines, with access points into the center of the site from both the west and the east sidewalks. Pedestrians can also access the site from the northwest corner of the property, where the proposed sidewalk will connect to an existing public sidewalk that leads from the site to Scovill Street.

Internal Connectivity – a five-foot wide sidewalk has been provided along the west, north, and east sides of the site, connecting to the public sidewalk along the south side, and with access to the center of the site.

Bicycle Parking – bicycle parking is included at three locations on the site, in front of the apartment building and to the north of the row houses. Twenty-one spaces will be provided in total.

Tree Preservation – the plan indicates that healthy indigenous trees will be preserved when possible, in addition to more trees being planted.

Open Space Provision – the plan includes landscaped open spaces in the central commons area, around the perimeter walking path, and around the detention basin along Windsor Road.

Passive Recreation – the perimeter sidewalk mentioned above will provide opportunities for passive recreation.

Architectural Consistency – the final plan submitted includes a variety of compatible building designs, materials, colors, and architecture that will unify the overall development. The buildings will be primarily brick on the front elevation, with hardi-board siding (a cement fiberboard that resembles wood clapboards) on the side and rear elevations. The trim will also be made of hardi-board. The apartment building will also use a stone trim at the corners to produce a quoin effect. Architectural details will be repeated in each of the buildings, helping to unify the development.

Architectural Design – the proposal includes energy efficient design and building construction, and materials. The proposed development utilizes modular construction, which is inherently “green” because of its construction methods and exterior wall spray foam insulation.

Summary of Staff Findings

1. A previous PUD development plan was approved for this site on April 2, 2012 by Ordinance No. 2012-04-035, which included approval for up to a total of 48 dwelling units.
2. Verdant Prairies LLC has submitted a preliminary and a final development plan to allow the construction of a residential planned unit development for 704 E Windsor Road. The proposed development allows for a total of 46 dwelling units, consisting of 15 one-story townhouses, 16 two-story townhouses, and one four-story apartment building with a total of 15 units.
3. The proposed development meets the definition of a PUD per Section XIII-3 of the Urbana Zoning Ordinance because it exceeds one-half acre in area and meets all four of the criteria: a) Mixed Use, b) Conservation, c) Infill, and d) Unique Development.
4. The proposed development is consistent with the general goals of a PUD. The proposed PUD is a high quality, mixed use infill development that will utilize flexible zoning standards to provide a development that is compatible with the surrounding area.
5. The proposed development is consistent with the Comprehensive Plan. The proposed development is responsive to goals 2, 3, 4, 5, 6, 13, 14, 15, 16, 17, 18, 19, 20, and 36 in the Comprehensive Plan.
6. The proposed preliminary Development Plan for the Verdant Prairies PUD includes zoning standards that vary from the standards established in the Urbana Zoning Ordinance pertaining to minimum lot size and width, maximum floor area ratio, minimum open space ratio, minimum setbacks, maximum building height for the fifteen-unit apartment building, and parking for Lot 118.
7. The proposed preliminary development plan incorporates the following recommended design features: transition area, lighting, street lighting, access, internal connectivity, bicycle parking, tree preservation, open space, passive recreational facilities, architectural consistency and architectural design.

Options

The Plan Commission has the following options for recommendations to the City Council regarding Plan Case No. 2218-PUD-13 (Preliminary PUD):

1. Recommend approval as submitted; or
2. Recommend approval of the Preliminary Development Plan, including any conditions; or
3. Recommend disapproval of the Preliminary Development Plan as submitted.

The Plan Commission has the following options for recommendations to the City Council regarding Plan Case No. 2219-PUD-13 (Final PUD):

1. Recommend approval of the Final Development Plan as submitted; or
2. Recommend approval of the Final Development Plan, including any conditions; or
3. Recommend disapproval of the Final Development Plan as submitted.

Staff Recommendation

Based on the evidence presented in the discussion above, and without the benefit of considering additional evidence that may be presented at the public hearing, staff recommends the Plan Commission forward Case No. 2218-PUD-13 (Preliminary PUD) to the City Council with a recommendation for **APPROVAL**.

Based on the evidence presented in the discussion above, and without the benefit of considering additional evidence that may be presented at the public hearing, staff recommends the Plan Commission forward Case No. 2219-PUD-13 (Final PUD) to the City Council with a recommendation for **APPROVAL** with the following waivers:

1. Minimum lot size shall be no less than 1600 square feet.
2. Average lot width shall be no less than 17 feet.
3. Maximum floor area ratio shall be as necessary to construct the PUD as presented herein.
4. Minimum open space ratio shall be as necessary to construct the PUD as presented herein.
5. Minimum front yard setback shall be no less than 1.5 feet for Lot 133 and no less than 7 feet for all other lots.
6. Minimum side yard setback shall be no less than 1.5 feet for Lot 118.
7. Minimum rear yard setback shall be no less than 1.5 feet for Lots 118 to 133.
8. The apartment building on Lot 101 shall be a maximum of 51 feet 7 inches in height.
9. Access drives serving single-family homes and duplexes may be allowed to be up to 100% of the total lot width.
10. Lot 118 shall be provided a permanent easement to two parking spaces in Lot 117 as shown on the preliminary plat.

Attachments: Exhibit A: Location and Existing Land Use Map
Exhibit B: Existing Zoning Map
Exhibit C: Future Land Use Map
Exhibit D: PUD Preliminary & Final Applications
Exhibit E: Proposed Site Development & Architectural Drawings
Exhibit F: Ordinance No. 2012-04-035
Exhibit G: Table XIII-2

cc: Gary Olsen, AIA, Olsen + Associates Architects, 3121 Village Office Place, Champaign, IL 61822
Bryan Bradshaw
Brant Muncaster

Exhibit A: Location & Land Use Map

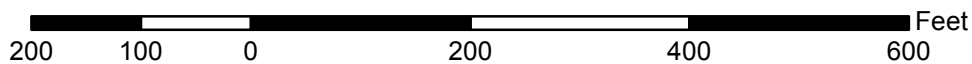
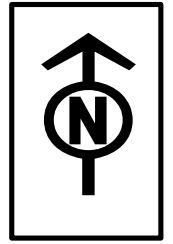
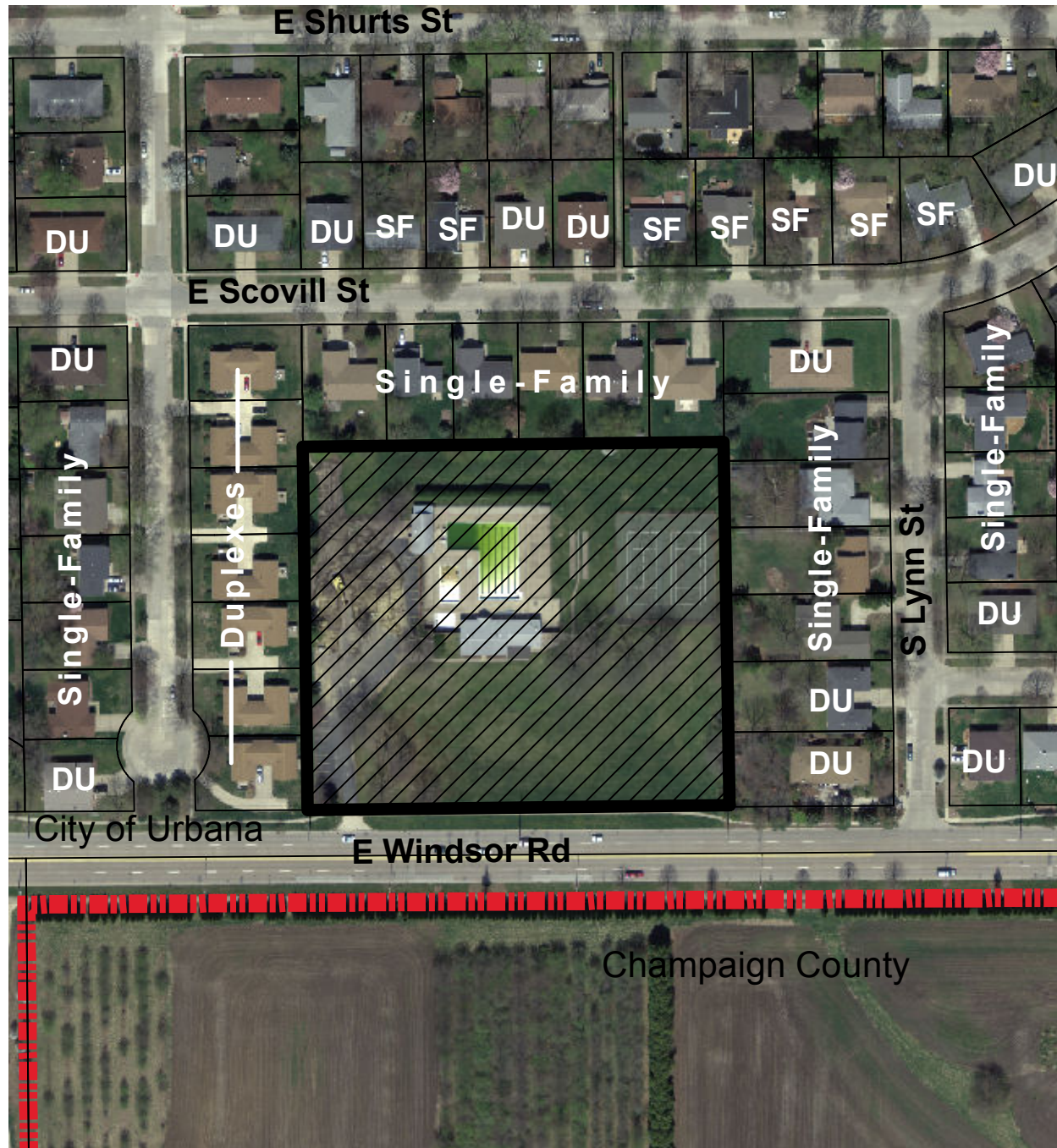

Case: 2218-PUD-13 & 2219-PUD-13
 Subject: Preliminary & Final PUD Applications
 Location: 704 E Windsor Rd, Urbana
 Petitioner: Verdant Prairies, LLC

 Subject Property
 Corporate Limits

Exhibit B: Zoning Map

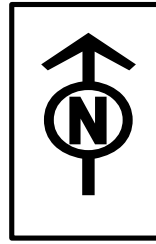
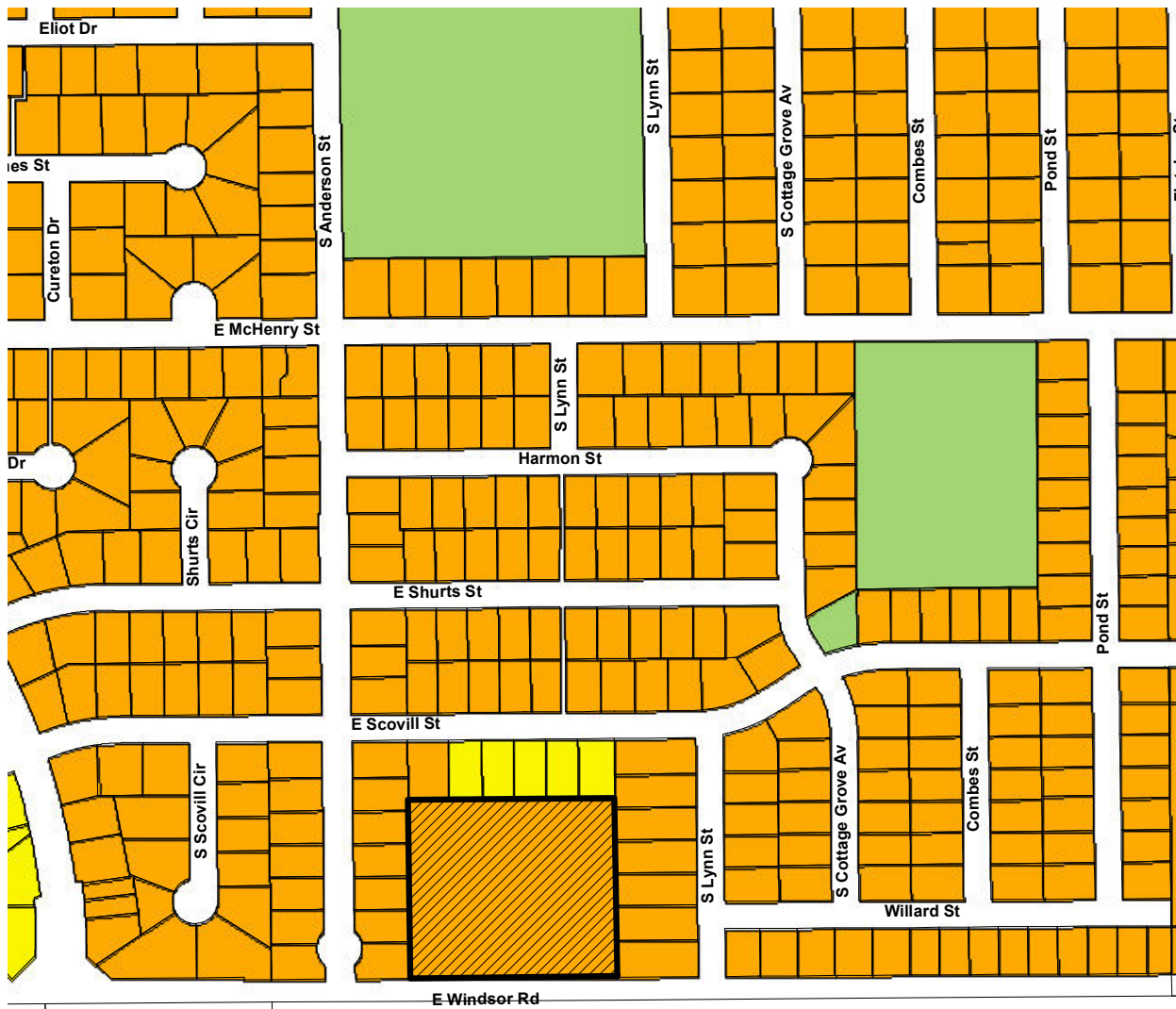



City of Urbana

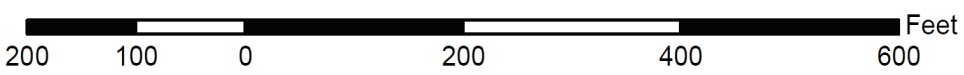



Champaign County



Case: 2218-PUD-13 & 2219-PUD-13
 Subject: Preliminary & Final PUD Applications
 Location: 704 E Windsor Rd, Urbana
 Petitioner: Verdant Prairies, LLC

 Subject Property

 Corporate Limits

-  CRE
-  R1
-  R2
-  R3

Prepared 11/13/13 by Community Development Services - rpn

Exhibit C: Future Land Use Map

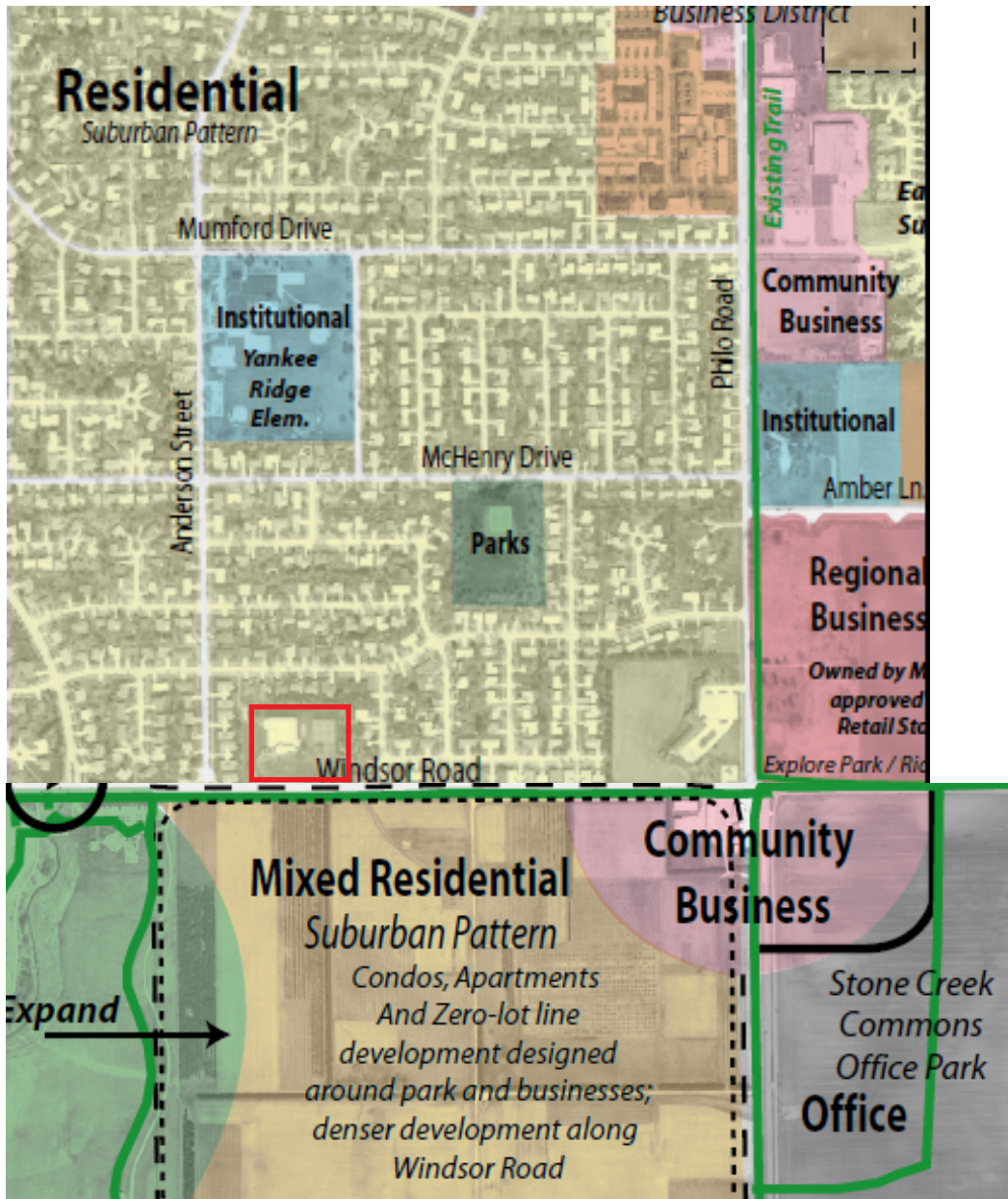
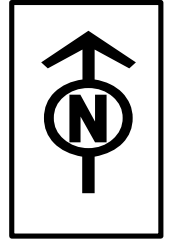

Source: 2005 Comprehensive Plan, Future Land Use Maps 13 & 14



Case: 2218-PUD-13 & 2219-PUD-13
 Subject: Preliminary & Final PUD Applications
 Location: 704 E Windsor Rd, Urbana
 Petitioner: Verdant Prairies, LLC

 Subject properties



Application for a
Planned Unit Development
Preliminary Development Plan

Plan
Commission

APPLICATION FEE - \$350.00

Applicants are also responsible for paying the cost of legal publication fees. The fees usually run from \$75.00 to \$125.00. The applicant is billed separately by the News-Gazette.

PLEASE DO NOT WRITE IN THIS SPACE – FOR OFFICE USE ONLY

Date Petition Filed _____ Plan Case No. _____
Fee Paid - Check No. _____ Amount: _____ Date _____

PLEASE PRINT OR TYPE THE FOLLOWING INFORMATION

1. APPLICANT CONTACT INFORMATION

Name of Applicant(s): **VERDANT PRAIRIES, LLC** Phone: **217-359-3453**
Address (street/city/state/zip code): **3121 VILLAGE OFFICE PLACE, CHAMPAIGN, IL 61822**
Email Address: **OLSENARCHITECTS@GMAIL.COM**
Property interest of Applicant(s) (Owner, Contract Buyer, etc.): **OWNER**

2. OWNER INFORMATION

Name of Owner(s): **VERDANT PRAIRIES, LLC** Phone: **217-359-3453**
Address (street/city/state/zip code): **3121 VILLAGE OFFICE PLACE, CHAMPAIGN, IL 61822**
Email Address: **OLSENARCHITECTS@GMAIL.COM**
Is this property owned by a Land Trust? Yes No
If yes, please attach a list of all individuals holding an interest in said Trust.

NOTE: Applications must be submitted and signed by the owners of more than 50% of the property's ownership.

3. PROPERTY INFORMATION

Name of Planned Unit Development: **VERDANT PRAIRIES VILLAGE**
Address/Location of Subject Site: **704 E. WINDSOR RD., URBANA, IL 61801**
PIN # of Location: **93-21-21-357-024**
Lot Size: **4.097 ACRES**
Current Zoning Designation: **R-3: SINGLE AND TWO-FAMILY RESIDENTIAL**

Current Land Use (*vacant, residence, grocery, factory, etc*): **VACANT - FORMER SWIMMING POOL CLUB**

Proposed Land Use: **RESIDENTIAL SUBDIVISION**

Present Comprehensive Plan Designation: **RESIDENTIAL – SUBURBAN LAND USE DESIGNATION**

How does this request conform to the Comprehensive Plan? **THE PROPOSED INFILL RESIDENTIAL DEVELOPMENT WILL PROVIDE A VARIETY OF HOUSING TYPES THAT WILL BE COMPATIBLE WITH THE SURROUNDING NEIGHBORHOODS.**

Legal Description: **SEE ATTACHED**

4. CONSULTANT INFORMATION

Name of Architect(s): GARY L. OLSEN, AIA, OLSEN + ASSOCIATES ARCHITECTS Phone: **217-359-3453**

Address (*street/city/state/zip code*): **3121 VILLAGE OFFICE PLACE, CHAMPAIGN, IL 61822**

Email Address: **OLSENARCHITECTS@GMAIL.COM**

Name of Engineers(s): BRYAN BRADSHAW, PE, BKB ENGINEERING, INC. Phone: **217-531-2971**

Address (*street/city/state/zip code*): **301 N. NEIL ST, SUITE 400, CHAMPAIGN, IL 61820**

Email Address: **BBRADSHAW@BKBENG.COM**

Name of Surveyor(s): BRYAN BRADSHAW, PLS, BKB ENGINEERING, INC. Phone: **217-531-2971**

Address (*street/city/state/zip code*): **301 N. NEIL ST, SUITE 400, CHAMPAIGN, IL 61820**

Email Address: **BBRADSHAW@BKBENG.COM**

Name of Professional Site Planner(s): GARY L. OLSEN, AIA, OLSEN + ASSOCIATES ARCHITECTS Phone: **217-359-3453**

Address (*street/city/state/zip code*): **3121 VILLAGE OFFICE PLACE, CHAMPAIGN, IL 61822**

Email Address: **OLSENARCHITECTS@GMAIL.COM**

Name of Attorney(s): MARC R. MILLER - MILLER & HENDREN, LLP Phone: **217-352-2171**

Address (*street/city/state/zip code*): **30 E. MAIN ST., #200, CHAMPAIGN, IL 61820**

Email Address: **MRM@MHLAWOFFICE.COM**

5. PLANNED UNIT DEVELOPMENT REQUIREMENTS

Has the applicant arranged for a preliminary conference as specified in Section XIII-3.F of the Zoning Ordinance?

Yes No Date of Preliminary Conference: **9/4/2013 AND 9/12/2013**

Type of PUD proposed: *(See Section XIII-3.A for descriptions of the following.)*

Residential Commercial Mixed Use Industrial

In order to qualify as a PUD, the development plan must include a gross site area of **at least one-half acre** and meet **at least one** of the following:

- a) *Mixed-Use.* Either in the same building or with a “campus” approach, provide for a mixture of single-family, two-family, multi-family, commercial, office, and/or recreational uses.
- b) *Conservation.* Protect natural, cultural and/or historical resources and harmoniously utilize such features as part of the development. This may include environmentally sensitive or “green” building and site design.
- c) *Infill.* Redevelop properties within the urban area that are vacant or underutilized due to obstacles such as lot layout, utility configuration, and road access.
- d) *Unique Development.* Development that significantly responds to the goals and objectives of the Comprehensive Plan and other relevant plans and policies and/or addresses unique features of the site.

Briefly describe the proposed PUD and how it meets the above criteria. (Attach additional sheets if necessary)

THE PROPOSED VERDANT PRAIRIES VILLAGE PUD ALSO MEETS ALL FOUR OF THE CRITERIA DEFINED IN THE URBANA ZONING ORDINANCE. THE PROPOSED PUD WILL BE AN INFILL DEVELOPMENT, SURROUNDED ON THREE SIDES BY A MATURE NEIGHBORHOOD AND WITH FULL STREET AND UTILITY ACCESS. IN ADDITION, IT WOULD PROVIDE A VARIETY OF HOUSING TYPES, THEREBY MEETING THE MIXED USE CRITERIA, AND WOULD INCORPORATE GREEN BUILDING TECHNIQUES AND SITE DESIGN FEATURES, THEREBY MEETING THE CONSERVATION CRITERIA. THE PROPOSED PROJECT WOULD ALSO FURTHER SPECIFIC GOALS AND OBJECTIVES OF THE COMPREHENSIVE PLAN, DETAILED BELOW.

Provide a narrative explaining how the proposed PUD is consistent with the following general goals of a PUD. In doing so, please identify which goals are applicable to the PUD and why.

- a) To encourage high quality non-traditional, mixed use, and/or conservation development in areas identified in the Comprehensive Plan;
- b) To promote infill development in a manner consistent with the surrounding area;
- c) To promote flexibility in subdivision and development design where necessary;
- d) To provide public amenities not typically promoted by the Zoning Ordinance;
- e) To promote development that is significantly responsive to the goals, objectives, and future land uses of the Urbana Comprehensive Plan;
- f) To provide a higher level of street and pedestrian connectivity within the development and the surrounding neighborhood in accordance with the Urbana Comprehensive Plan.
- g) To coordinate architectural styles, building forms, and building relationships within the development and the surrounding neighborhood;
- h) To encourage the inclusion of a variety of public and private open space, recreational facilities, greenways and trails not typically promoted by the Zoning Ordinance;
- i) To conserve, to the greatest extent possible, unique natural and cultural features, environmentally sensitive areas, or historic resources, and to utilize such features in a harmonious fashion.

(Attach additional sheets if necessary) **THE PROPOSED VERDANT PRAIRIES VILLAGE PUD IS CONSISTENT WITH GOALS A, B, C, E, G, AND H. THE PROPOSED PUD IS A HIGH QUALITY, MIXED USE INFILL DEVELOPMENT THAT WILL UTILIZE FLEXIBLE ZONING STANDARDS TO PROVIDE A DEVELOPMENT THAT IS CONSISTENT WITH THE SURROUNDING AREA. THE PROPOSED DEVELOPMENT IS RESPONSIVE TO MANY OF THE GOALS OF THE COMPREHENSIVE PLAN INCLUDING PROVIDING A VARIETY OF HOUSING TYPES, PRICES AND DESIGNS. A VARIETY OF COMPATIBLE BUILDING DESIGNS, MATERIALS, COLORS, AND ARCHITECTURAL STYLES WILL UNIFY THE OVERALL DEVELOPMENT. THE PROPOSAL INCLUDES AMENITIES SUCH AS MULTIPLE LANDSCAPED COMMONS AREAS AND A**

**RECREATIONAL WALKWAY AROUND THE ENTIRE SITE INCLUDING
DIRECT ACCESS TO SCOVILL STREET TO THE NORTH AND WINDSOR ROAD
TO THE SOUTH.**

Section XIII-3 of the Urbana Zoning Ordinance allows for the following standards to be varied from, if justified by the circumstances particular to the site or the project and approved by the City Council: lot width, building height, floor area ratio, setbacks, off-street parking and loading, landscaping and screening, and fences.

Briefly describe any/all waivers that are anticipated as part of the development plan including justification for the waivers. Please note for each waiver whether approval is requested now, at the preliminary development plan approval stage, or will be requested at the final development plan approval stage. (Attach additional sheets if necessary)

A. SEE ATTACHED

B. _____

C. _____

D. _____

Does the proposed development plan involve a zoning map amendment? Yes No
If yes, please describe:

Does the proposed development plan involve a subdivision plat? Yes No

Table XIII-2 of the Urbana Zoning Ordinance outlines recommended design features for PUD's. Please identify which design features are anticipated to be incorporated into the proposed PUD.

SEE ATTACHED

5. PRELIMINARY DEVELOPMENT PLAN SUBMITTAL REQUIREMENTS:

A preliminary development plan must be submitted with this application and should be conceptual but must minimally include the following materials: *(Blanks are provided to help in determining whether submission is complete)*

- A general location map of suitable scale which shows the location of the property within the community and adjacent parcels.
- A site inventory and analysis to identify site assets and constraints, such as floodplains, wetlands, soils, wooded areas, existing infrastructure and easements, existing buildings, and public lands.
- A conceptual site plan with the following information:
 - Any adjacent and/or contiguous parcels of land owned or controlled by the petitioner(s).
 - Proposed land uses, building locations, and any conservation areas.
 - Existing and proposed streets, sidewalks, and multi-use paths.
 - Buffers between different land uses.
- Any other information deemed necessary by Secretary of the Plan Commission.

NOTE: *If additional space is needed to accurately answer any question, please attach extra pages to the application.*

By submitting this application, you are granting permission for City staff to post on the property a temporary yard sign announcing the public hearing to be held for your request.

CERTIFICATION BY THE APPLICANT

I certify all the information contained in this application form or any attachment(s), document(s) or plan(s) submitted herewith are true to the best of my knowledge and belief, and that I am either the property owner or authorized to make this application on the owner's behalf.

Applicant's Signature

Date

LEGAL DESCRIPTION:

The South 384.305 feet of the East 453.39 feet of the West 758.39 feet of the Southwest Quarter of Section 21, Township 19 North, Range 9 East of the Third Principal Meridian, in Champaign County, Illinois, and a part of the Southwest Quarter of Section 21, Township 19 North, Range 9 East of the Third Principal Meridian, in Champaign County, Illinois, described as follows:

Beginning at the Northeast corner of Lot 362 in Ennis Ridge Fifteenth Subdivision, a subdivision in Champaign County, Illinois, as per plat recorded in Plat Book "U" at page 16 in the Recorder's office of Champaign County, Illinois; thence East and parallel to the North line of said Lot 362, as extended to the Northwest corner of Lot 369 in said Ennis Ridge Fifteenth Subdivision; then South along the West line of Lot 369, 370 and 371 in said Ennis Ridge Fifteenth Subdivision to the Northeast corner of the Windsor Swim Club Co. property, as per deed recorded in Book 807 at page 208 as document no. 738389 in the Recorder's office of Champaign County, Illinois; thence West along the North line of said Windsor Swim Club Co. property to the East line of Lot 360 in Ennis Ridge Fifteenth Subdivision, thence North along the East line of said Lot 360, and East line of Lots 361 and 362 in Ennis Ridge Fifteenth Subdivision, to the place of beginning, in Champaign County, Illinois, EXCEPT the following described real estate:

Beginning at a steel pipe monument at the Northeast corner of Lot 362 of Ennis Ridge Fifteenth Subdivision; thence on a local bearing North 89°30'30" East, along the South right-of-way of Scovill Street in the City of Urbana, Illinois, 453.38 feet to an iron pipe set in concrete at the Northwest corner of Lot 369 of said Subdivision; thence South 0°43'20" East, along a Westerly line of said Subdivision, 130.00 feet to a steel rod marker; thence South 89°30'30" West, 453.38 feet to a steel rod marker located on an Easterly line of said Subdivision; thence North 0°43'20" West, along said Easterly line, 130.0 feet to a point of beginning, in Champaign County, Illinois.

Waivers / Variances:

Zoning Ordinance

1. Minimum lot size shall be 6,000 square feet (table VI-3). A variance is requested to allow a lot size no less than 1850 square feet.
2. Average lot width shall be 60 feet (table VI-3). A variance is requested to allow a lot width no less than 16 feet.
3. Maximum floor area ratio shall be 0.40 (table VI-3). A variance is requested to allow a floor area ratio as necessary to construct the PUD as generally presented.
4. Minimum open space ratio shall be 0.40 (table VI-3). A variance is requested to allow a minimum open ratio as necessary to construct the PUD as generally presented.
5. Minimum front yard setback shall be 15 feet (table VI-3). A variance is requested to allow a front yard setback of no less than 7 feet and no less than 1.5 feet for Lot 134.
6. Minimum side yard setback shall be 5 feet (table VI-3). A variance is requested to allow a side yard setback of no less than 1.5 feet for lot 118.
7. Minimum rear yard setback shall be 10 feet (table VI-3). A variance is requested to allow a rear yard setback of no less than 1.5 feet for lots 118 to 134.

Subdivision Ordinance

1. Waive Sec. 21-36. (A) (2) Each buildable lot within a new development shall be adjacent to public street. Lots 118 to 125 are not contiguous to a public right-of-way. These lots contain vehicle access via a private alley ingress-egress easement and pedestrian access via commons lot located along the north and south frontage of the lots.
2. Section 21-42 (B) (5) (d) It is unlawful for any person to construct or cause to be constructed any drainage facility for the purpose of the detention or retention of water within a distance of ten (10) feet plus one-and-one-half (1 1/2) times the depth of any drainage facility adjacent to the right-of-way of any public highway. A variance is requested to construct a stormwater detention basin with the 50-year high water elevation of the basin no less than 8 feet from the right-of-way line.
3. Waive Sec. 21-37. (A) (1) Sidewalks shall be provided on both sides of each street in residential developments. A proposed sidewalk is located around the perimeter of the site and across the interior of the site. The proposed sidewalk within the development far exceeds the ordinance requirements in total length. A variance is requested only for the location of the sidewalk.

4. Sec. 21-37. (B) (7) The width of the access portion of the lot connecting to the street shall be a minimum of twenty (20) feet. A variance is requested to allow a frontage length of no less than 16 feet.
5. Waive Sec. 21-39. (C) No private alleys will be permitted. A 20 foot wide private alley is proposed for this development and will meet or exceed all Urbana requirements for a public alley.

Justifications

All waivers became necessary as the project evolved from a condominium project to a zero-lot line subdivision. Because of the higher costs to develop an infill project, it became necessary to retain the same number of units for the new subdivision as were in the approved Condominium PUD. The high costs associated with demolition of the vacant pool club need to be distributed throughout the 47 units to make the project economically feasible.

The higher densities within the privately owned lots enabled larger shared open spaces for the enjoyment of the overall community.

TABLE XIII-2 COMMENTARY:

Transition Area – the zero-lot line units on the north and east portion of the site (adjacent to the existing single family residences) are one-story in height to maximize compatibility with the adjacent properties. The apartment building is located in the southwest portion of the site closest to the entrance off Windsor Road and adjacent to the existing duplex properties.

Lighting – the plans specify low-wattage LED lighting.

Street Lighting – the proposal states that street lighting will be coordinated with the City Engineer to maximize safety and visibility while minimizing intrusion into private areas.

Access – the plans include a public pedestrian walkway access to Scovill Street, as well to the existing sidewalk on Windsor Road. A public cul-de-sac is provided for vehicle access.

Internal Connectivity – a five-foot wide sidewalk has been provided along the west, north, and east sides of the site, connecting to the public sidewalk along Windsor Road and at the northwest corner of the site. Internal pedestrian circulation is excellent.

Bicycle Parking –bicycle parking is included in the preliminary development plan in multiple locations on the site.

Tree Preservation – the plan indicates that healthy indigenous trees will be preserved when possible.

Open Space Provision – the preliminary development plan includes landscaped open spaces within the middle of an oversized cul-de-sac. It is anticipated this will be utilized as a formal and informal gathering place for the enjoyment of the neighborhood. A dry detention basin is also provided and can be utilized as open space.

Passive Recreation – the perimeter / interior sidewalks and open landscaped cul-de-sac area will provide opportunities for passive recreation.

Architectural Consistency & Design – A variety of compatible building designs, materials, colors, and architecture will unify the overall development. In addition, the proposal includes energy efficient design and building construction, as well as materials.



Application for a
Planned Unit Development
Final Development Plan

Plan
Commission

APPLICATION FEE - \$250.00

Applicants are also responsible for paying the cost of legal publication fees. The fees usually run from \$75.00 to \$125.00. The applicant is billed separately by the News Gazette.

DO NOT WRITE IN THIS SPACE – FOR OFFICE USE ONLY

Date Petition Filed _____ Plan Case No. _____
Fee Paid - Check No. _____ Amount: _____ Date _____

1. APPLICANT CONTACT INFORMATION

Name of Applicant(s): **VERDANT PRAIRIES, LLC** Phone: **217-359-3453**
Address (street/city/state/zip code): **3121 VILLAGE OFFICE PLACE, CHAMPAIGN, IL 61822**
Email Address: **OLSENARCHITECTS@GMAIL.COM**
Property interest of Applicant(s) (Owner, Contract Buyer, etc.): **OWNER**

2. OWNER INFORMATION

Name of Owner(s): **VERDANT PRAIRIES, LLC** Phone: **217-359-3453**
Address (street/city/state/zip code): **3121 VILLAGE OFFICE PLACE, CHAMPAIGN, IL 61822**
Email Address: **OLSENARCHITECTS@GMAIL.COM**
Is this property owned by a Land Trust? Yes No
If yes, please attach a list of all individuals holding an interest in said Trust.

NOTE: Applications must be submitted and signed by the owners of more than 50% of the property's ownership

3. PROPERTY INFORMATION

Name of Planned Unit Development: **VERDANT PRAIRIES VILLAGE**
Address/Location of Subject Site: **704 E. WINDSOR RD., URBANA, IL 61801**
PIN # of Location: **93-21-21-357-024**
Lot Size: **4.097 ACRES**
Current Zoning Designation: **R-3: SINGLE AND TWO-FAMILY RESIDENTIAL**
Current Land Use (vacant, residence, grocery, factory, etc): **VACANT - FORMER SWIMMING POOL CLUB**

Proposed Land Use: **RESIDENTIAL SUBDIVISION**

Legal Description: **SEE ATTACHED**

4. CONSULTANT INFORMATION

Name of Architect(s): GARY L. OLSEN, AIA, OLSEN + ASSOCIATES ARCHITECTS Phone: **217-359-3453**

Address (*street/city/state/zip code*): **3121 VILLAGE OFFICE PLACE, CHAMPAIGN, IL 61822**
Email Address: **OLSENARCHITECTS@GMAIL.COM**

Name of Engineers(s): BRYAN BRADSHAW, PE, BKB ENGINEERING, INC. Phone: **217-531-2971**

Address (*street/city/state/zip code*): **301 N. NEIL ST, SUITE 400, CHAMPAIGN, IL 61820**
Email Address: **BBRADSHAW@BKBENG.COM**

Name of Surveyor(s): BRYAN BRADSHAW, PLS, BKB ENGINEERING, INC. Phone: **217-531-2971**

Address (*street/city/state/zip code*): **301 N. NEIL ST, SUITE 400, CHAMPAIGN, IL 61820**
Email Address: **BBRADSHAW@BKBENG.COM**

Name of Professional Site Planner(s): GARY L. OLSEN, AIA, OLSEN + ASSOCIATES ARCHITECTS Phone: **217-359-3453**

Address (*street/city/state/zip code*): **3121 VILLAGE OFFICE PLACE, CHAMPAIGN, IL 61822**
Email Address: **OLSENARCHITECTS@GMAIL.COM**

Name of Attorney(s): MARC R. MILLER - MILLER & HENDREN, LLP Phone: **217-352-2171**

Address (*street/city/state/zip code*): **30 E. MAIN ST., #200, CHAMPAIGN, IL 61820**
Email Address: **MRM@MHLAWOFFICE.COM**

5. PLANNED UNIT DEVELOPMENT REQUIREMENTS

Has a preliminary development plan for the proposed PUD been approved within the last twelve months? Yes No

Date City Council Approval: **CONCURRENT**

Ordinance No.:

Does the Final Development Plan substantially conform to the approved Preliminary Development Plan? In what ways does it differ? (*Attach additional sheets if necessary*)

NO

Does the proposed development plan involve a zoning map amendment? Yes No
If yes, please describe: _____

Does the proposed development plan involve a subdivision plat? Yes No

Section XIII-3 of the Urbana Zoning Ordinance allows for the following standards to be varied from, if justified by the circumstances particular to the site or the project and approved by the City Council: lot width, building height, floor area ratio, setbacks, off-street parking and loading, landscaping and screening, and fences.

Briefly describe any/all waivers that are anticipated as part of the development plan including justification for the waivers. Please note for each waiver whether approval was secured at the preliminary development plan approval stage or approval is requested now at the final development plan approval stage. *(Attach additional sheets if necessary)*

A. SEE ATTACHED

B. _____

C. _____

D. _____

6. CRITERIA FOR APPROVAL

Explain how the proposed development is conducive to the public convenience at the proposed location.

THE DEVELOPMENT WILL UTILIZE A TRACT OF LAND THAT HAS BEEN VACANT SINCE 2009 TO CREATE A HIGH QUALITY, MIXED USE RESIDENTIAL COMMUNITY.

Explain how the proposed development is designed, located, and proposed to be operated so that it will not be unreasonably injurious or detrimental to the surrounding areas, or otherwise injurious or detrimental to the public welfare.

THE SUBDIVISION ROADWAY, SIDEWALK AND STORMWATER DETENTION

FACILITIES WILL BE DESIGNED TO MEET OR EXCEED CITY OF URBANA ORDINANCES.

Explain how the proposed development is consistent with the goals, objectives, and future land uses of the Urbana Comprehensive Plan and other relevant plans and polices.

THE PROPOSED PUD IS A HIGH QUALITY, MIXED USE INFILL DEVELOPMENT THAT WILL UTILIZE FLEXIBLE ZONING STANDARDS TO PROVIDE A DEVELOPMENT THAT IS CONSISTENT WITH THE SURROUNDING AREA. THE PROPOSED DEVELOPMENT IS RESPONSIVE TO MANY OF THE GOALS OF THE COMPREHENSIVE PLAN INCLUDING PROVIDING A VARIETY OF HOUSING TYPES, PRICES AND DESIGNS. A VARIETY OF COMPATIBLE BUILDING DESIGNS, MATERIALS, COLORS, AND ARCHITECTURAL STYLES WILL UNIFY THE OVERALL DEVELOPMENT. THE PROPOSAL INCLUDES AMENITIES SUCH AS MULTIPLE LANDSCAPED COMMONS AREAS AND A RECREATIONAL SIDEWALK.

Explain how the proposed development is consistent with the purpose and goals of the Section XIII-3, Planned Unit Developments of the Zoning Ordinance.

THE PROPOSED VERDANT PRAIRIES VILLAGE PUD WILL BE AN INFILL DEVELOPMENT, SURROUNDED ON THREE SIDES BY A MATURE NEIGHBORHOOD AND WITH FULL STREET AND UTILITY ACCESS. IN ADDITION, IT WOULD PROVIDE A VARIETY OF HOUSING TYPES, THEREBY MEETING THE MIXED USE CRITERIA, AND WOULD INCORPORATE GREEN BUILDING TECHNIQUES AND SITE DESIGN FEATURES, THEREBY MEETING THE CONSERVATION CRITERIA. THE PROPOSED PROJECT WOULD ALSO FURTHER SPECIFIC GOALS AND OBJECTIVES OF THE COMPREHENSIVE PLAN, DETAILED BELOW.

Table XIII-2 of the Urbana Zoning Ordinance outlines recommended design features for PUD's. Please identify which design features are incorporated into the proposed PUD and explain how the proposed development is responsive to the relevant recommended design features. (*See Attached*) (*Attach additional sheets if necessary*)

- A. **SEE ATTACHED**

- B.

- C.

- D.

- E.

- F.

- G.

7. FINAL DEVELOPMENT PLAN SUBMITTAL REQUIREMENTS

A final development plan must be submitted with this application and shall minimally contain the following materials: (*Blanks are provided to help in determining whether submission is complete*)

- A general location map at a suitable scale which shows the location of the property within the community and adjacent parcels.
- A specific site plan with the following information:
 - The location of proposed structures and existing structures that will remain, with height and gross floor area notes for each structure.
 - The circulation system indicating pedestrian, bicycle, and motor vehicle movement systems, including existing and proposed public right-of-way; transit stops; easements and other reservations of land; the location of existing and proposed curb cuts, off-street parking and loading spaces, including service drives; sidewalks and other walkways.
 - A landscape plan indicating the general location of trees, shrubs, and ground cover (proposed or existing).

- A preliminary stormwater plan indicating the general location of impervious surfaces, detention/retention basins, and the basic storm sewer layout.
- A preliminary utilities plan indicating the general location of sanitary sewers, electricity, gas, telecommunications, and similar services.
- The location of street and pedestrian lighting, including lamp intensity and height.
- Conceptual elevations of all proposed commercial buildings and conceptual typical elevations of residential buildings. Scaled elevations shall identify building materials, the location, height, and materials for screening walls and fences, storage areas for trash and rooftop equipment.
- Design, location, display area, and height of any proposed signage subject to the regulations of the Urbana Zoning Ordinance.
- A development program that provides general information about the development, including desired residential and commercial tenants, housing price targets, estimated construction costs, and any other information that conveys that purpose and intent of the development.
- A development schedule indicating:
 - The approximate date when construction of the project will begin.
 - The phases in which the project will be built, if applicable, and the approximate date when construction of each phase will begin.
 - The approximate dates when the development of each of the stages will be completed.
- Any other information deemed necessary by the Secretary of the Plan Commission.

NOTE: If additional space is needed to accurately answer any question, please attach extra pages to the application.

By submitting this application, you are granting permission for City staff to post on the property a temporary yard sign announcing the public hearing to be held for your request.

CERTIFICATION BY THE APPLICANT

I certify all the information contained in this application form or any attachment(s), document(s) or plan(s) submitted herewith are true to the best of my knowledge and belief, and that I am either the property owner or authorized to make this application on the owner's behalf.

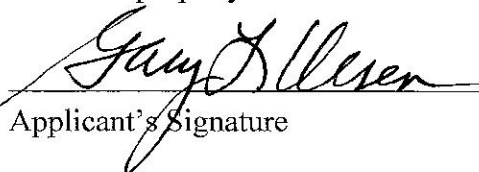
 Applicant's Signature

OCTOBER, 28, 2013
 Date

LEGAL DESCRIPTION:

The South 384.305 feet of the East 453.39 feet of the West 758.39 feet of the Southwest Quarter of Section 21, Township 19 North, Range 9 East of the Third Principal Meridian, in Champaign County, Illinois, and a part of the Southwest Quarter of Section 21, Township 19 North, Range 9 East of the Third Principal Meridian, in Champaign County, Illinois, described as follows:

Beginning at the Northeast corner of Lot 362 in Ennis Ridge Fifteenth Subdivision, a subdivision in Champaign County, Illinois, as per plat recorded in Plat Book "U" at page 16 in the Recorder's office of Champaign County, Illinois; thence East and parallel to the North line of said Lot 362, as extended to the Northwest corner of Lot 369 in said Ennis Ridge Fifteenth Subdivision; then South along the West line of Lot 369, 370 and 371 in said Ennis Ridge Fifteenth Subdivision to the Northeast corner of the Windsor Swim Club Co. property, as per deed recorded in Book 807 at page 208 as document no. 738389 in the Recorder's office of Champaign County, Illinois; thence West along the North line of said Windsor Swim Club Co. property to the East line of Lot 360 in Ennis Ridge Fifteenth Subdivision, thence North along the East line of said Lot 360, and East line of Lots 361 and 362 in Ennis Ridge Fifteenth Subdivision, to the place of beginning, in Champaign County, Illinois, EXCEPT the following described real estate:

Beginning at a steel pipe monument at the Northeast corner of Lot 362 of Ennis Ridge Fifteenth Subdivision; thence on a local bearing North 89°30'30" East, along the South right-of-way of Scovill Street in the City of Urbana, Illinois, 453.38 feet to an iron pipe set in concrete at the Northwest corner of Lot 369 of said Subdivision; thence South 0°43'20" East, along a Westerly line of said Subdivision, 130.00 feet to a steel rod marker; thence South 89°30'30" West, 453.38 feet to a steel rod marker located on an Easterly line of said Subdivision; thence North 0°43'20" West, along said Easterly line, 130.0 feet to a point of beginning, in Champaign County, Illinois.

Waivers / Variances:

Zoning Ordinance

1. Minimum lot size shall be 6,000 square feet (table VI-3). A variance is requested to allow a lot size no less than 1850 square feet.
2. Average lot width shall be 60 feet (table VI-3). A variance is requested to allow a lot width no less than 16 feet.
3. Maximum floor area ratio shall be 0.40 (table VI-3). A variance is requested to allow a floor area ratio as necessary to construct the PUD as generally presented.
4. Minimum open space ratio shall be 0.40 (table VI-3). A variance is requested to allow a minimum open ratio as necessary to construct the PUD as generally presented.
5. Minimum front yard setback shall be 15 feet (table VI-3). A variance is requested to allow a front yard setback of no less than 7 feet and no less than 1.5 feet for Lot 134.
6. Minimum side yard setback shall be 5 feet (table VI-3). A variance is requested to allow a side yard setback of no less than 1.5 feet for lot 118.
7. Minimum rear yard setback shall be 10 feet (table VI-3). A variance is requested to allow a rear yard setback of no less than 1.5 feet for lots 118 to 134.

Subdivision Ordinance

1. Waive Sec. 21-36. (A) (2) Each buildable lot within a new development shall be adjacent to public street. Lots 118 to 125 are not contiguous to a public right-of-way. These lots contain vehicle access via a private alley ingress-egress easement and pedestrian access via commons lot located along the north and south frontage of the lots.
2. Section 21-42 (B) (5) (d) It is unlawful for any person to construct or cause to be constructed any drainage facility for the purpose of the detention or retention of water within a distance of ten (10) feet plus one-and-one-half (1 1/2) times the depth of any drainage facility adjacent to the right-of-way of any public highway. A variance is requested to construct a stormwater detention basin with the 50-year high water elevation of the basin no less than 8 feet from the right-of-way line.
3. Waive Sec. 21-37. (A) (1) Sidewalks shall be provided on both sides of each street in residential developments. A proposed sidewalk is located around the perimeter of the site and across the interior of the site. The proposed sidewalk within the development far exceeds the ordinance requirements in total length. A variance is requested only for the location of the sidewalk.

4. Sec. 21-37. (B) (7) The width of the access portion of the lot connecting to the street shall be a minimum of twenty (20) feet. A variance is requested to allow a frontage length of no less than 16 feet.
5. Waive Sec. 21-39. (C) No private alleys will be permitted. A 20 foot wide private alley is proposed for this development and will meet or exceed all Urbana requirements for a public alley.

Justifications

All waivers became necessary as the project evolved from a condominium project to a zero-lot line subdivision. Because of the higher costs to develop an infill project, it became necessary to retain the same number of units for the new subdivision as were in the approved Condominium PUD. The high costs associated with demolition of the vacant pool club need to be distributed throughout the 47 units to make the project economically feasible.

The higher densities within the privately owned lots enabled larger shared open spaces for the enjoyment of the overall community.

TABLE XIII-2 COMMENTARY:

Transition Area – the zero-lot line units on the north and east portion of the site (adjacent to the existing single family residences) are one-story in height to maximize compatibility with the adjacent properties. The apartment building is located in the southwest portion of the site closest to the entrance off Windsor Road and adjacent to the existing duplex properties.

Lighting – the plans specify low-wattage LED lighting.

Street Lighting – the proposal states that street lighting will be coordinated with the City Engineer to maximize safety and visibility while minimizing intrusion into private areas.

Access – the plans include a public pedestrian walkway access to Scovill Street, as well to the existing sidewalk on Windsor Road. A public cul-de-sac is provided for vehicle access.

Internal Connectivity – a five-foot wide sidewalk has been provided along the west, north, and east sides of the site, connecting to the public sidewalk along Windsor Road and at the northwest corner of the site. Internal pedestrian circulation is excellent.

Bicycle Parking –bicycle parking is included in the preliminary development plan in multiple locations on the site.

Tree Preservation – the plan indicates that healthy indigenous trees will be preserved when possible.

Open Space Provision – the preliminary development plan includes landscaped open spaces within the middle of an oversized cul-de-sac. It is anticipated this will be utilized as a formal and informal gathering place for the enjoyment of the neighborhood. A dry detention basin is also provided and can be utilized as open space.

Passive Recreation – the perimeter / interior sidewalks and open landscaped cul-de-sac area will provide opportunities for passive recreation.

Architectural Consistency & Design – A variety of compatible building designs, materials, colors, and architecture will unify the overall development. In addition, the proposal includes energy efficient design and building construction, as well as materials.

ATTACHMENT B: PROPOSED PUD DESCRIPTION

The approach to the Verdant Prairies Village north of Windsor Road in Urbana, Illinois, is a divided roadway located near the southwest corner of the site that leads to a simple one way, east-west cul-de-sac on the north half of the site that connects to all villas, townhouses, apartments, and parking areas of Verdant Prairies Village.

The site slopes approximately 4' from the centerline of the north property line to major drainage inlets along the Verdant Prairies Place drive to the dry storm water detention basin adjacent to the south property line. All site roads, driveways, exterior parking areas, and walkways shall be concrete.

The former Windsor Swim Club site will be the home to forty-six (46) dwelling units. The overall size, mass and height of each unit type will start on the north half of the site as fifteen "zero lot line" single story villas. Further south and east are sixteen "zero lot line" two story townhouses between Verdant Prairies Place on the west and the property line on the east. One, three story 15 unit apartment building with underbuilding parking and elevator access is located on the southwest corner of the site, just north of Windsor Road and west of Verdant Prairies Place drive. These taller townhomes and apartment building will act as a sound and visual barrier between the north half of our site and Windsor Road. They also will serve to enclose the rest of the site from Windsor Road, a major east-west corridor on the south side of the twin cities in Champaign County. The lower villa homes are located on the naturally higher ground elevations on the north and the taller structures are located on the lower elevations on the south.

Street lighting will be generally low wattage and will be focused downwards to the site. All street lighting will be coordinated with the City Engineer to maximize safety and visibility and to minimize intrusion into private areas. General and landscape lighting shall be primarily low wattage LED with each entry door and garage door to have a minimum of one exterior light.

A five foot wide pedestrian walkway will surround the entire site. This walkway shall also connect to the existing walkway near the northwest corner of the site and to the public sidewalk adjacent to the south property line. At several locations along the east and west property lines, landscaped walkway intersections will lead into the center of the site to conveniently provide varied walking paths to bring you through the site and back home more efficiently.

Parking for 130 spaces shall be provided in private garages, and on open parking spaces. Assuming all forty-six (46) dwelling units are constructed, each dwelling unit would have access to an average of 2.83 parking spaces, or say, two spaces per dwelling unit and thirty-eight (38) additional spaces for visiting family and friends.

Parking for bicycles will be located to the north of the townhouse units at two locations and east of the south stairwell of the apartment building.

ATTACHMENT C: PUD NARRATIVE

Verdant Prairies Village (VPV) will be a very energy efficient, “green” community. Early in the planning process we actually discussed calling our development GREEN ACRES. As many know, Olsen+Associates Architects-Planners was the first architect to bring a major construction alternative to all wood frame buildings that are planned to be four stories or less in height. A project that we named, Verdant Prairies Apartments, 606 E. Stoughton, Champaign, IL, is now the tallest, modular frame residential structure in the Midwest. This apartment building was completed in mid-August 2011. On our site, close to Wright Street and the University of Illinois Engineering Campus, we are able to accommodate ninety-six students. We expect to have about the same number of residents living on our 4+ acre VPV site when it has been totally built out.

All of our dwelling units shall be built as modular components of the total residence. Each module goes through approximately eighteen (18) different stages of construction in our “modular” partner’s plant which is located approximately 90 minutes west of Champaign. Each phase of work is coordinated and inspected by an “in house” phase foreman and also a third party inspector hired by the Owners. By the end of each module’s journey through the plant, not only is the framing and structural system complete, but all other required systems, including mechanical, electrical, fire alarm, plumbing, and fire suppression, are also completed within the module before it driven on a flatbed trailer to the site. It is also typical that most interior finishes such as drywall on walls and ceilings, painting, flooring, doors, trim, built-in cabinetry and kitchen appliances, bathroom fixtures, ceiling lights, etc., are all installed in the plant. On the exterior walls of each module, windows, exterior doors, sheathing, Tyvek, and siding are also typically installed. When all modules for each residence are complete they are sent to the site, fully wrapped with heavy, striated fiberglass protective sheeting, and ready to be set on a prepared concrete foundation over a crawlspace or full basement.

Although this type of construction is inherently “green” because of its construction methods and exterior wall spray foam insulation, it also is a system adaptable to choices the future Owner may choose as upgrades. For instance, gas heating and air conditioning shall be included in the base cost of the new home, however, electric heating, heat pumps, geothermal, and solar sources shall all be considered as additional options to discuss with the architect. Solar collectors will be installed as Owner desired options on south facing roofs. Modular construction will allow the homes to be built better, faster, greener, and to be less expensive to buy and live in over time.

A variety of compatible building designs, materials, colors, and architecture will unify the overall development and create a pleasant setting for living, working, and playing together as a community. Wherever possible, healthy, indigenous trees and foliage will be left in place. A three phase landscaping plan will be designed for the site. The first phase of site landscaping will commence in conjunction with the completion of construction and sale of the fifth dwelling unit in the northwest corner of the site. During the landscape design of each walking path, the Owners of the properties which are adjacent to our property will have an opportunity to review our plans and improve them in a way that will be

approved by both parties. We want all neighbors to welcome this new community to the neighborhood, and we also want our neighbors to have an enhanced environment to live adjacent to because of our Verdant Prairies Village development.

ATTACHMENT D: Conceptual Site Design Narrative

Verdant Prairies Village (VPV) is committed to providing Low Impact Design (LID) solutions that will control runoff and pollution from the site. Fifteen percent (15%) of the total site area is dedicated for active infiltration of storm water.

The entire VPV site will be landscaped with native plantings that are durable, long-lived perennials and are naturally adapted to local growing conditions.

Storm water best management practices will be carefully utilized during construction to reduce pollutant loads and concentration and prevent downstream erosion. Structural controls such as silt fencing, inlet protection, straw wattles and concrete washout areas will be implemented. Site construction will be staged to allow the existing entrance and parking lot to be used to prevent tracking of soil on adjacent streets.

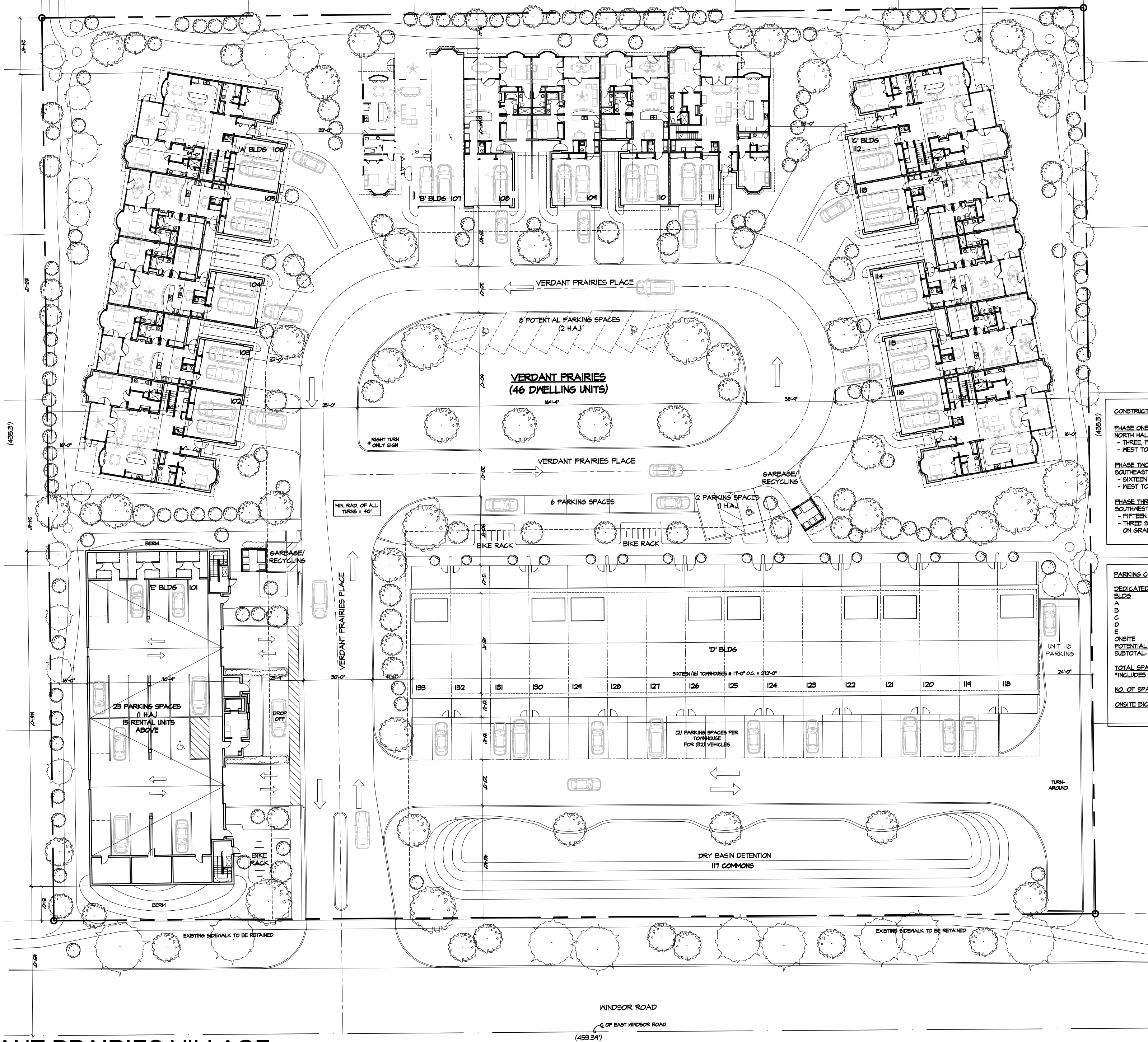

CONSTRUCTION PHASES

PHASE ONE
 NORTH HALF OF SITE
 - THREE, FIVE VILLA UNITS
 - WEST TO EAST SIDE OF SITE

PHASE TWO
 SOUTHEAST CORNER OF SITE
 - SIXTEEN TOWNHOUSE UNITS
 - WEST TO EAST SIDE OF SITE

PHASE THREE
 SOUTHWEST CORNER OF SITE
 - FIFTEEN APARTMENT UNITS
 - THREE STORIES OF UNITS OVER
 ON GRADE PARKING

PARKING CRITERIA

BLDG	ENCLOSED	OPEN	TOTAL
A	10	10	20
B	10	10	20
C	10	10	20
D	0	32	32
E	0	1	1
F	0	1	1
G	0	2	2
POTENTIAL	0	6	6
SUBTOTAL	32	74	106

TOTAL SPACES ON SITE = 130*
 *INCLUDES 8 POTENTIAL SPACES

NO. OF SPACES PER UNIT = 2.8

ONSITE BICYCLE PARKING = 30 @ (2) BIKES PER RACK

PRELIMINARY PLAT VERDANT PRAIRIES VILLAGE

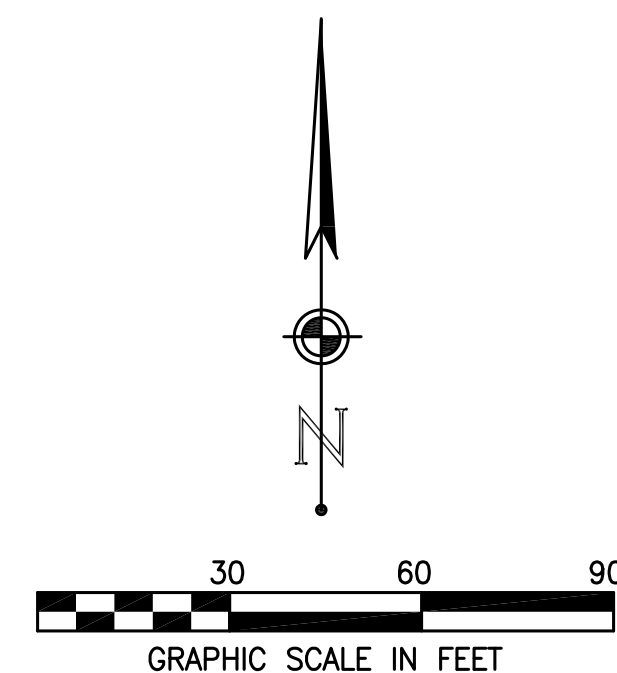

ENGINEER / SURVEYOR:

BKB ENGINEERING, INC.
301 N. NEIL ST., SUITE 400
CHAMPAIGN, IL 61820
(217) 531-2971 OFFICE
(217) 531-2211 FAX

OWNER / SUBDIVIDER:

VERDANT PRAIRIES, LLC
3121 VILLAGE OFFICE PLACE
CHAMPAIGN, IL 61822
(217) 359-3453

NOTES:

1. THE SITE IS LOCATED WITHIN THE CORPORATE LIMITS OF THE CITY OF URBANA, ILLINOIS.
2. ALL CONSTRUCTION WORK AND MATERIALS SHALL BE IN ACCORDANCE WITH THE CITY OF URBANA, ILLINOIS SUBDIVISION ORDINANCE AND ILLINOIS AMERICAN WATER COMPANY REGULATIONS.
3. STORM WATER DETENTION FACILITIES AND EROSION CONTROL SHALL BE DESIGNED AND CONSTRUCTED IN ACCORDANCE WITH THE CITY OF URBANA, ILLINOIS SUBDIVISION AND STORMWATER MANAGEMENT ORDINANCES.
4. LOT 117 IS SUBJECT TO UTILITY AND DRAINAGE EASEMENT COVERING ALL OF SAID LOT.
5. PROPOSED EASEMENTS SHALL BE PROVIDED AT FINAL PLATTING TO ACCOMMODATE ALL INGRESS/EGRESS, PUBLIC UTILITIES AND DRAINAGE WAYS.

SHEET LEGEND

-
-
-
-

APPROVED BY: THE URBANA PLAN COMMISSION OF THE CITY OF URBANA, ILLINOIS

DATE: _____ CHAIRPERSON: _____

APPROVED BY: THE CITY COUNCIL OF THE CITY OF URBANA, ILLINOIS, IN ACCORDANCE WITH ORDINANCE NO. _____

DATE: _____ BY: _____ MAYOR

ATTEST: _____ CITY CLERK

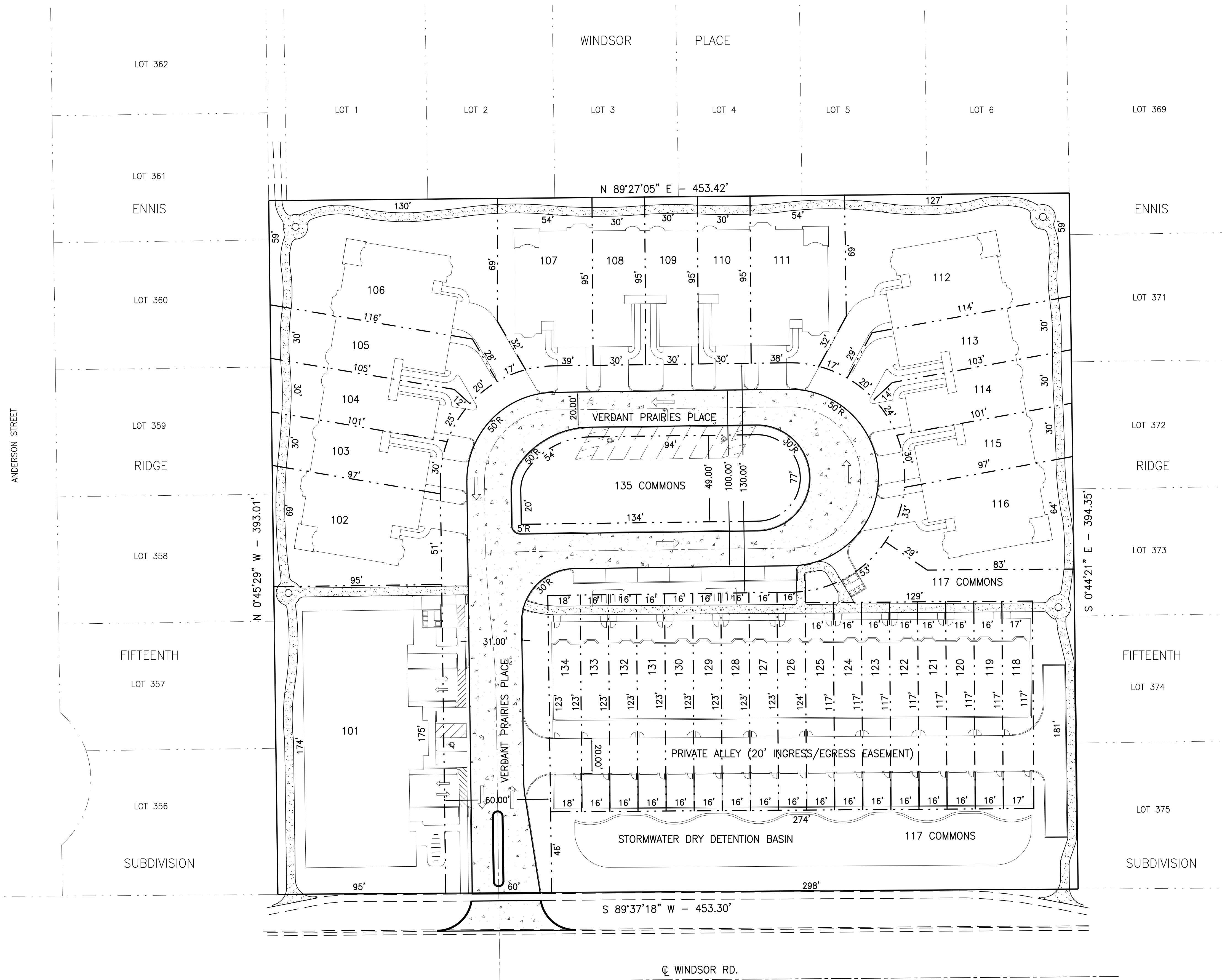

LOT NUMBER	AREA (S.F.)
101	16,607
102	5,709
103	2,918
104	3,205
105	3,739
106	9,522
107	4,949
108	2,834
109	2,831
110	2,827
111	4,926
112	9,286
113	3,713
114	3,188
115	2,914
116	5,399
117	19,323
118	2,037
119	1,870
120	1,870
121	1,870
122	1,870
123	1,870
124	1,870
125	1,870
126	1,966
127	1,963
128	1,961
129	1,960
130	1,958
131	1,957
132	1,955
133	1,953
134	2,211
135	7,227

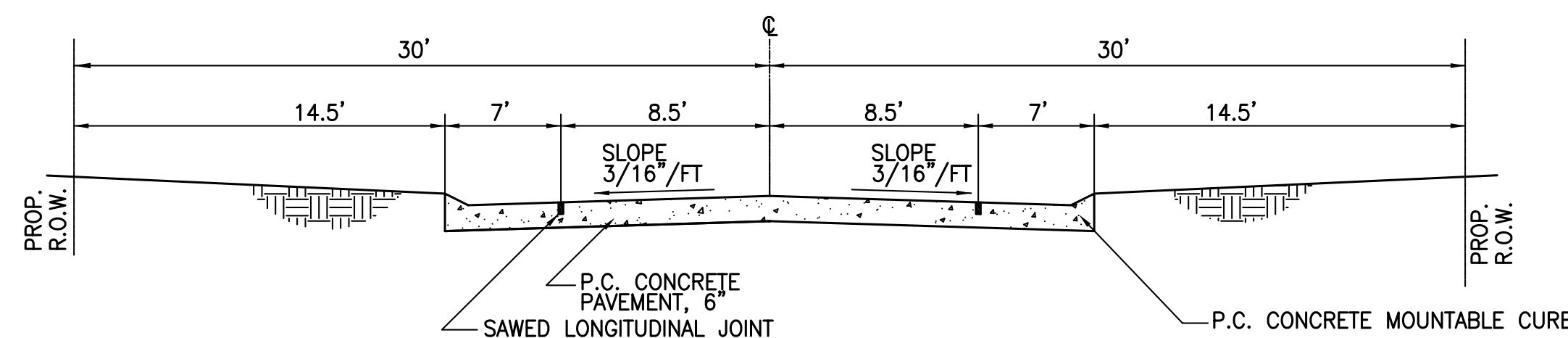

TYPICAL PAVEMENT SECTION

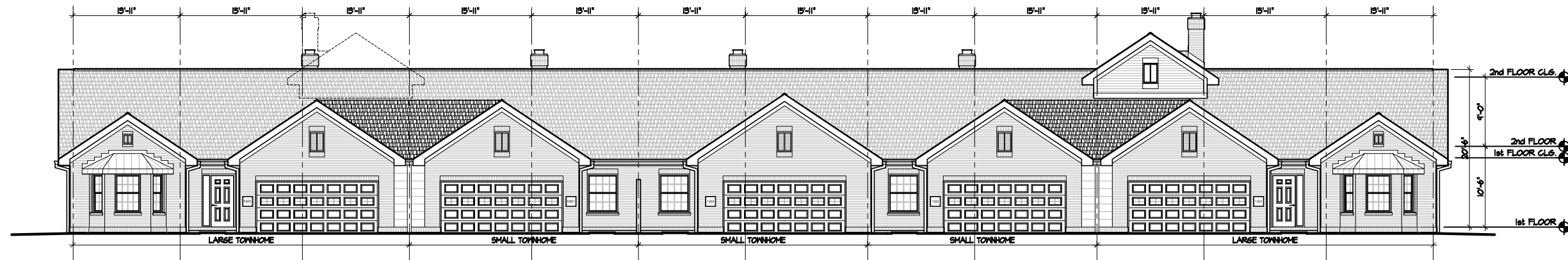

SOUTH ELEVATION

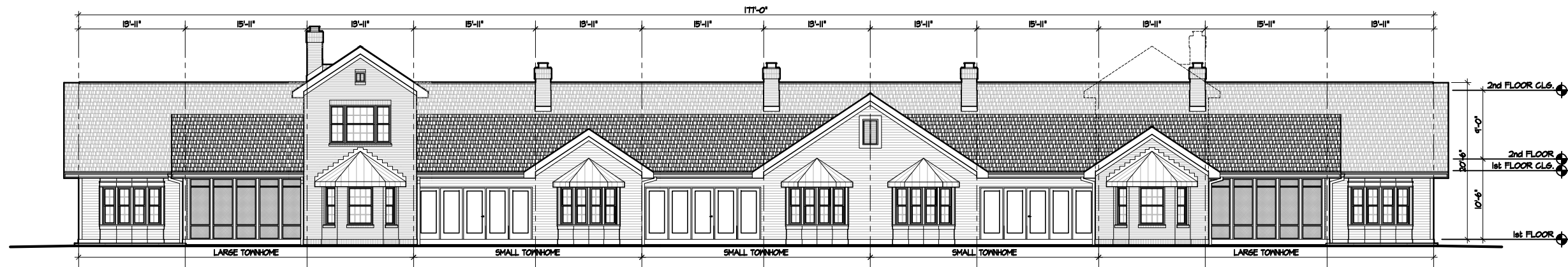

NORTH ELEVATION



EAST ELEVATION

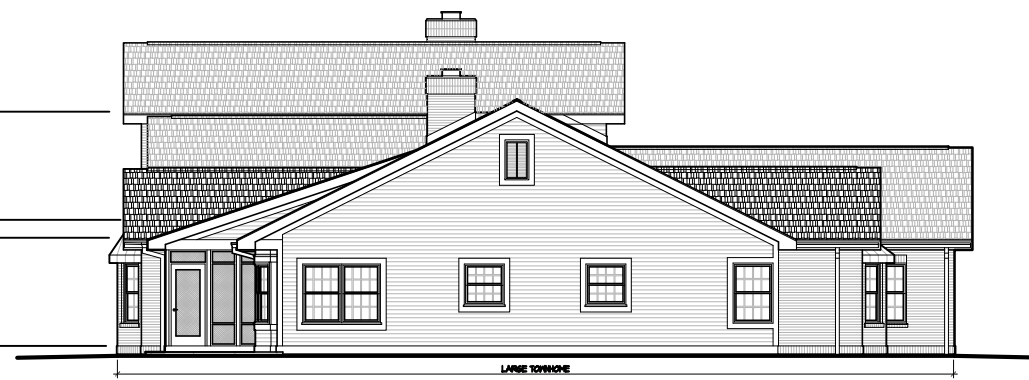

WEST ELEVATION

VERDANT PRAIRIES VILLAGE TOWNHOMES - 5 UNIT ELEVATIONS

BUILDING 'B'

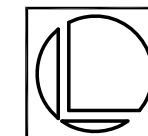

OLSEN+ASSOCIATES
 Architecture • Development • Planning
 3121 VILLAGE OFFICE PLACE • VILLAGE AT THE CROSSING
 CHAMPAIGN • ILLINOIS • 61822 • 217-369-3453



VERDANT PRAIRIES VILLAGE
TOWNHOMES FRONT ELEVATION (with 2nd floor option on End Townhome Unit)

SCALE: 3/16" = 1'-0" DATE 10-30-2013

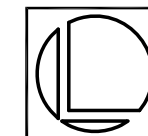

OLSEN+ASSOCIATES
Architecture • Development • Planning
3121 VILLAGE OFFICE PLACE • VILLAGE AT THE CROSSING
CHAMPAIGN • ILLINOIS • 61822 • 217-369-3463



VERDANT PRAIRIES VILLAGE
TOWNHOMES REAR ELEVATION

(with 2nd floor option on End Townhome Unit)

SCALE: 3/16" = 1'-0" DATE 10-30-2013

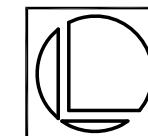

OLSEN+ASSOCIATES
Architecture • Development • Planning
3121 VILLAGE OFFICE PLACE • VILLAGE AT THE CROSSING
CHAMPAIGN • ILLINOIS • 61822 • 217-369-3453



VERDANT PRAIRIE VILLAGE
TOWNHOMES SIDE ELEVATION

(with 2nd floor option on End Townhome Unit)

SCALE: 3/16" = 1'-0" DATE 10-30-2013

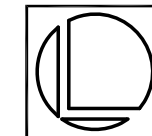

OLSEN+ASSOCIATES
Architecture • Development • Planning
3121 VILLAGE OFFICE PLACE • VILLAGE AT THE CROSSING
CHAMPAIGN • ILLINOIS • 61822 • 217-369-3453

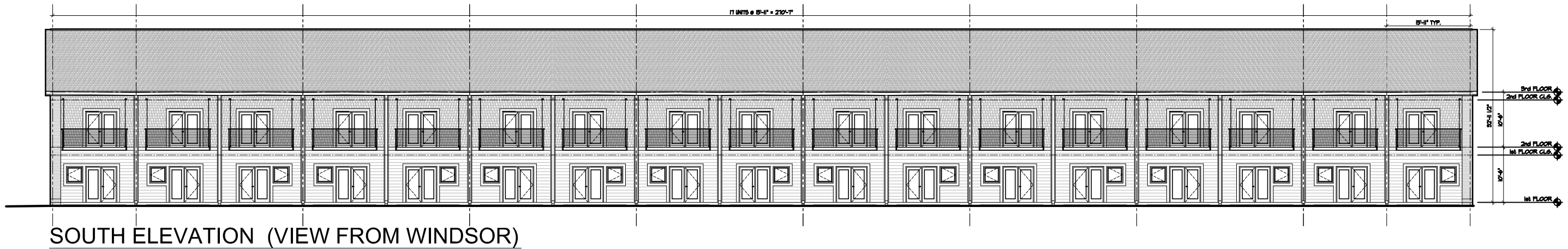
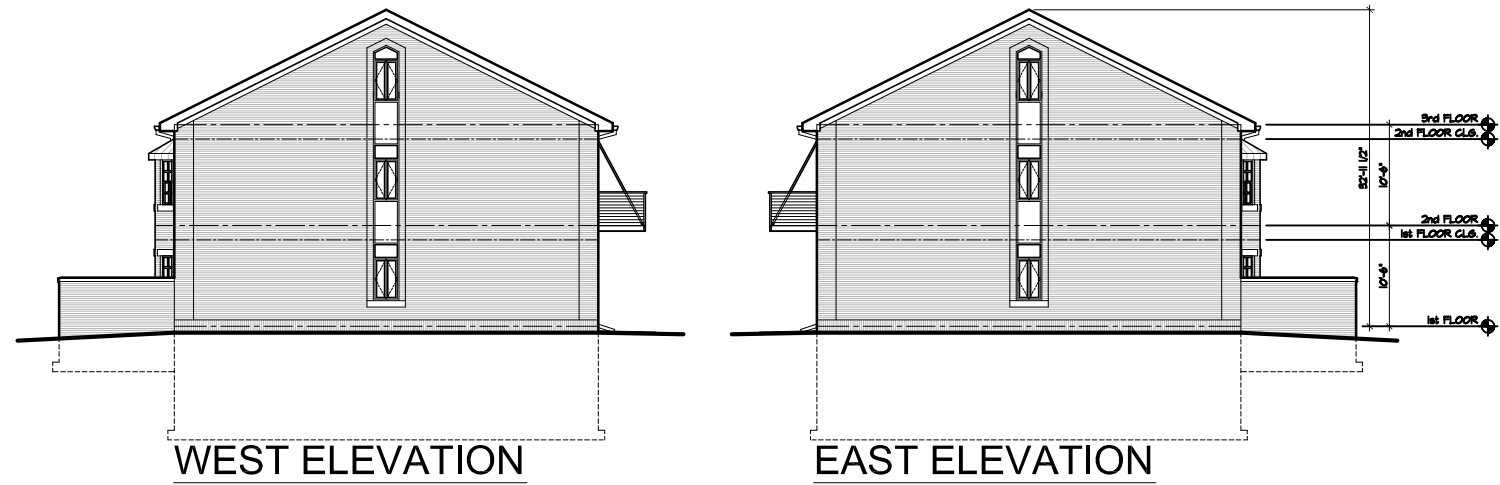

SOUTH ELEVATION (VIEW FROM WINDSOR)

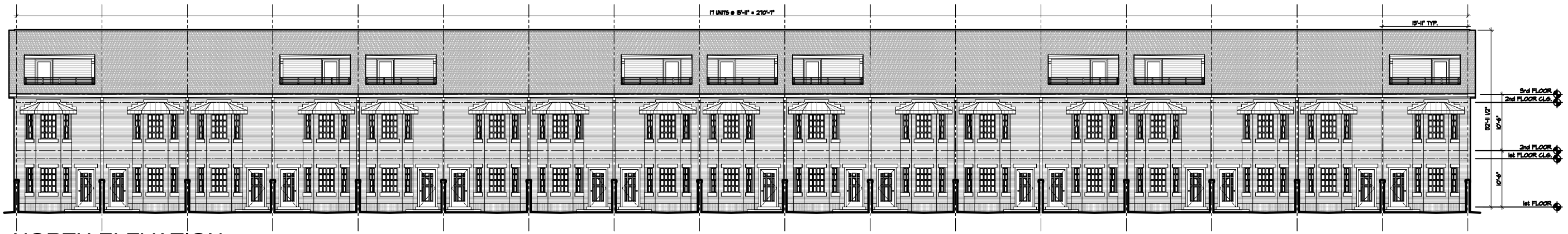

NORTH ELEVATION

VERDANT PRAIRIES VILLAGE - TOWNHOUSES 17 UNITS ELEVATIONS

BUILDING 'D'

SCALE: 1" = 20' DATE 10-30-2013

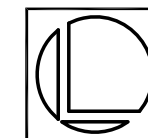

OLSEN + ASSOCIATES
 Architecture • Development • Planning
 3121 VILLAGE OFFICE PLACE • VILLAGE AT THE CROSSING
 CHAMPAIGN • ILLINOIS • 61822 • 217-369-3453



**VERDANT PRAIRIES VILLAGE - TOWNHOUSES
FRONT ELEVATION & BRICK FENCE ELEVATION (END UNIT SHOWN)**

SCALE: 1/4" = 1'-0" DATE 10-30-2013

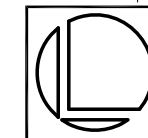

OLSEN + ASSOCIATES
 Architecture • Development • Planning
 3121 VILLAGE OFFICE PLACE • VILLAGE AT THE CROSSING
 CHAMPAIGN • ILLINOIS • 61822 • 217-369-3453

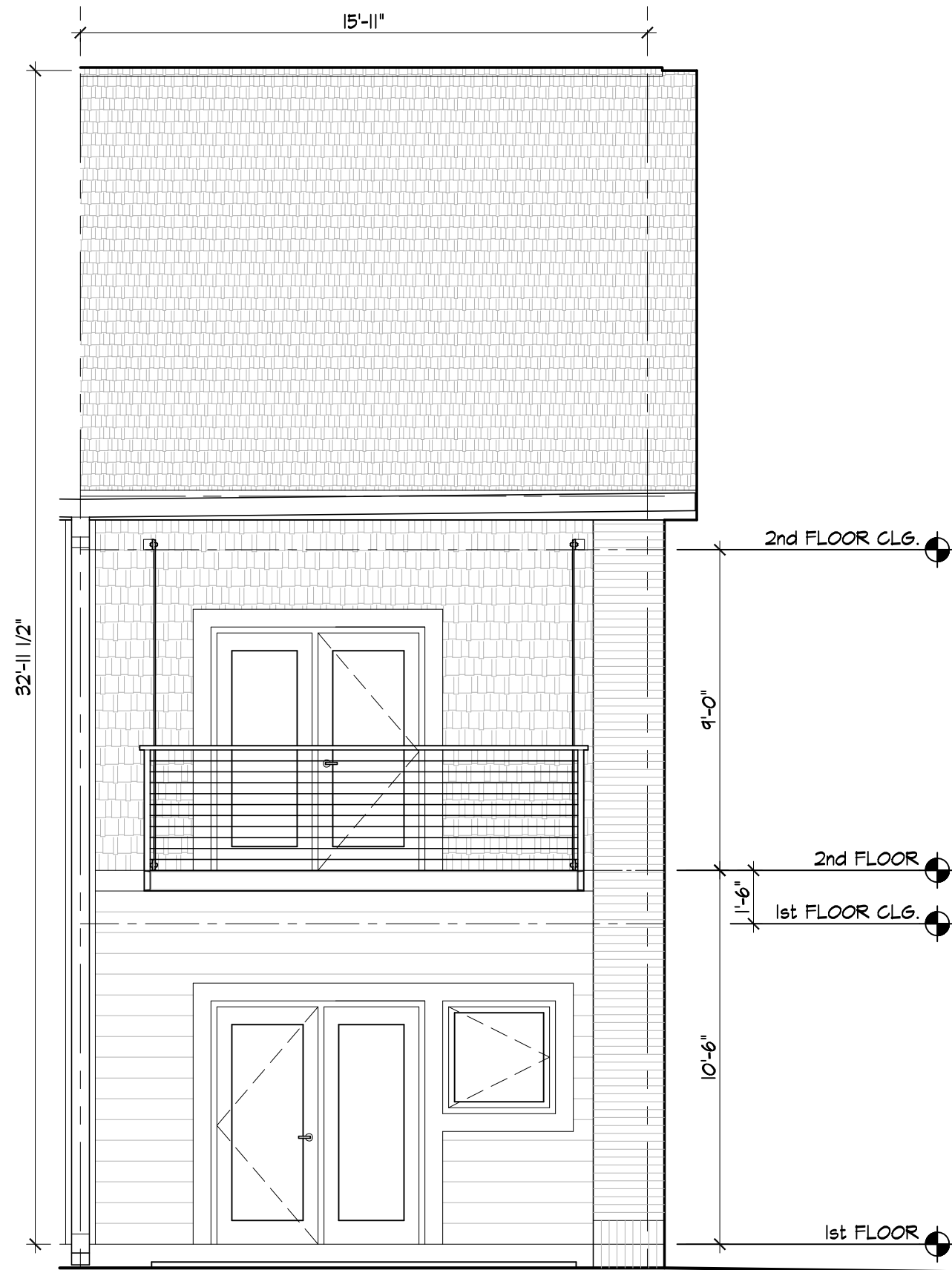

VERDANT PRAIRIES VILLAGE - TOWNHOUSES
REAR ELEVATION (END UNIT SHOWN)

SCALE: 1/4" = 1'-0" DATE 10-30-2013

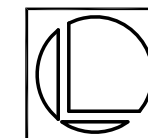

OLSEN + ASSOCIATES
Architecture • Development • Planning
3121 VILLAGE OFFICE PLACE • VILLAGE AT THE CROSSING
CHAMPAIGN • ILLINOIS • 61822 • 217-369-3453

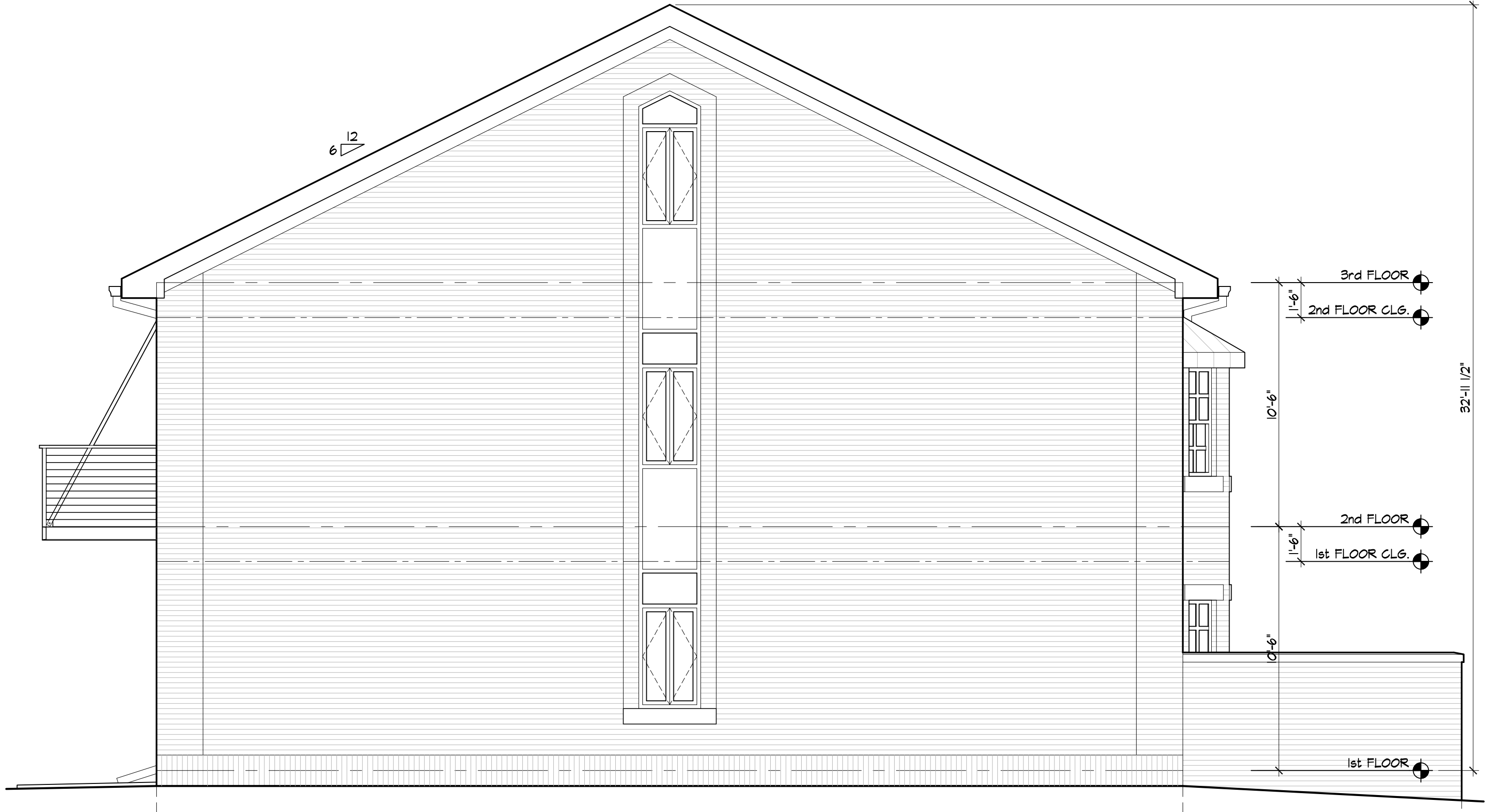

VERDANT PRAIRIES VILLAGE - TOWNHOUSES
END UNIT ELEVATION

SCALE: 1/4" = 1'-0" DATE 10-30-2013

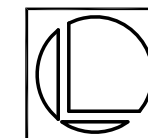

OLSEN + ASSOCIATES
 Architecture • Development • Planning
 3121 VILLAGE OFFICE PLACE • VILLAGE AT THE CROSSING
 CHAMPAIGN • ILLINOIS • 61822 • 217-369-3453

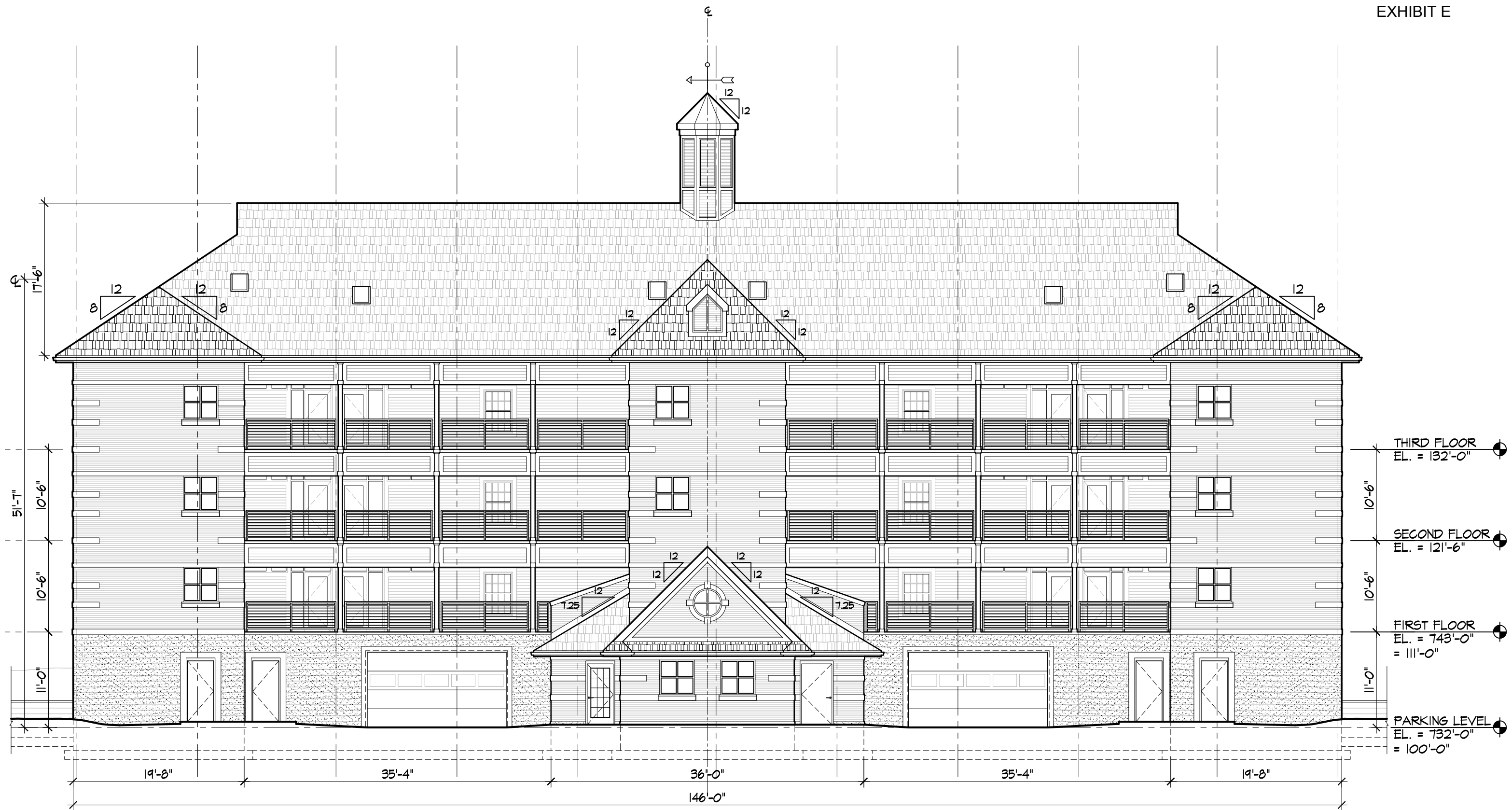

VERDANT PRAIRIES VILLAGE - VERDANT PRAIRIES PLACE APARTMENTS FRONT (EAST) ELEVATION

SCALE: 3/32" = 1'-0" DATE 11-7-2013

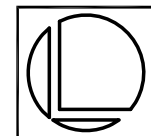

OLSEN+ASSOCIATES
Architecture • Development • Planning
3121 VILLAGE OFFICE PLACE • VILLAGE AT THE CROSSING
CHAMPAIGN • ILLINOIS • 61822 • 217-359-3453

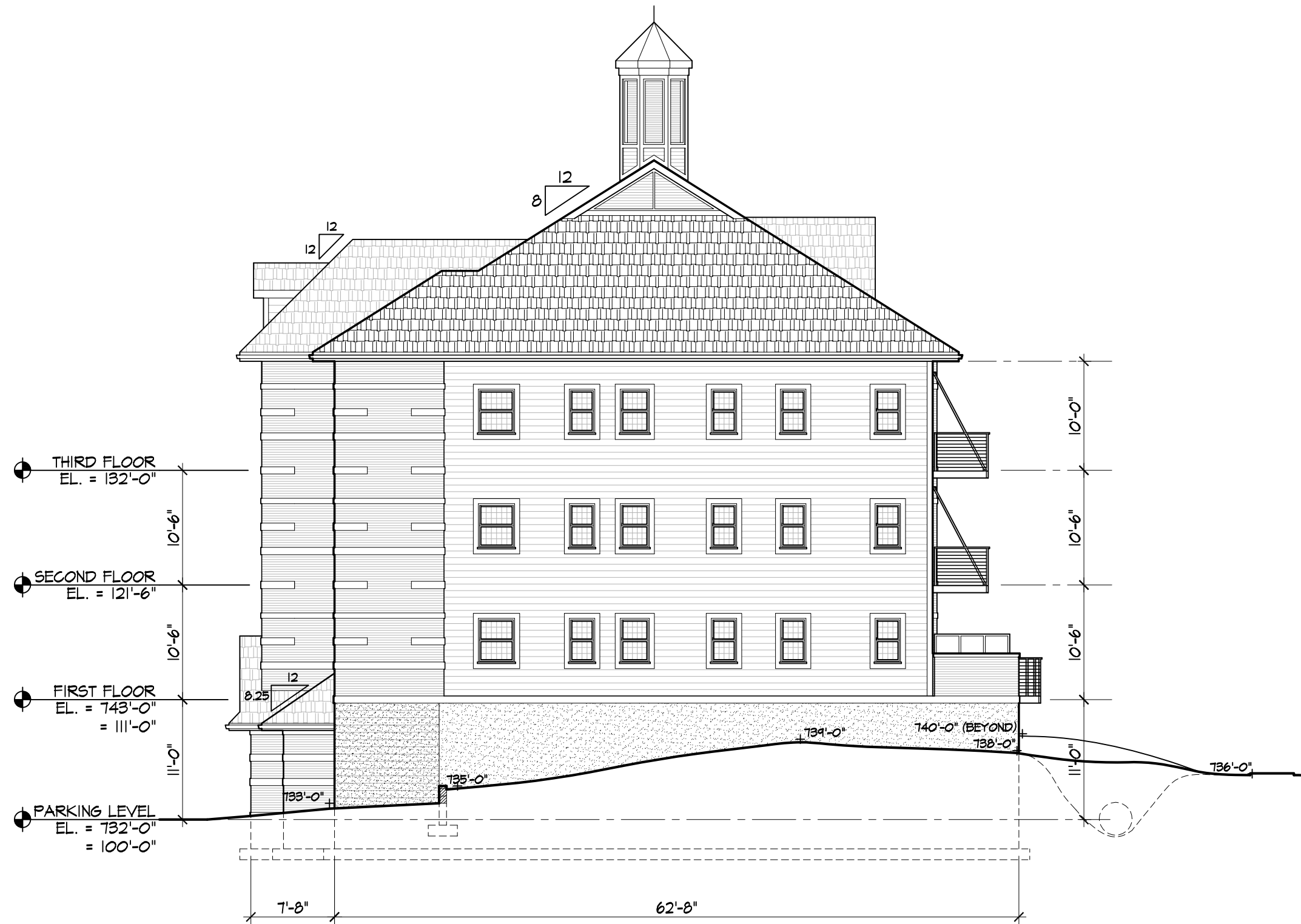

VERDANT PRAIRIES VILLAGE - VERDANT PRAIRIES PLACE APARTMENTS
NORTH ELEVATION

SCALE: 3/32" = 1'-0" DATE 11-7-2013

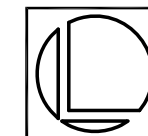

OLSEN+ASSOCIATES
 Architecture • Development • Planning
 3121 VILLAGE OFFICE PLACE • VILLAGE AT THE CROSSING
 CHAMPAIGN • ILLINOIS • 61822 • 217-369-3453



VERDANT PRAIRIES VILLAGE - VERDANT PRAIRIES PLACE APARTMENTS REAR (WEST) ELEVATION

SCALE: 3/32" = 1'-0" DATE 11-7-2013

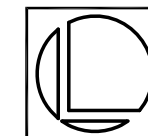

OLSEN+ASSOCIATES
Architecture • Development • Planning
3121 VILLAGE OFFICE PLACE • VILLAGE AT THE CROSSING
CHAMPAIGN • ILLINOIS • 61822 • 217-369-3463

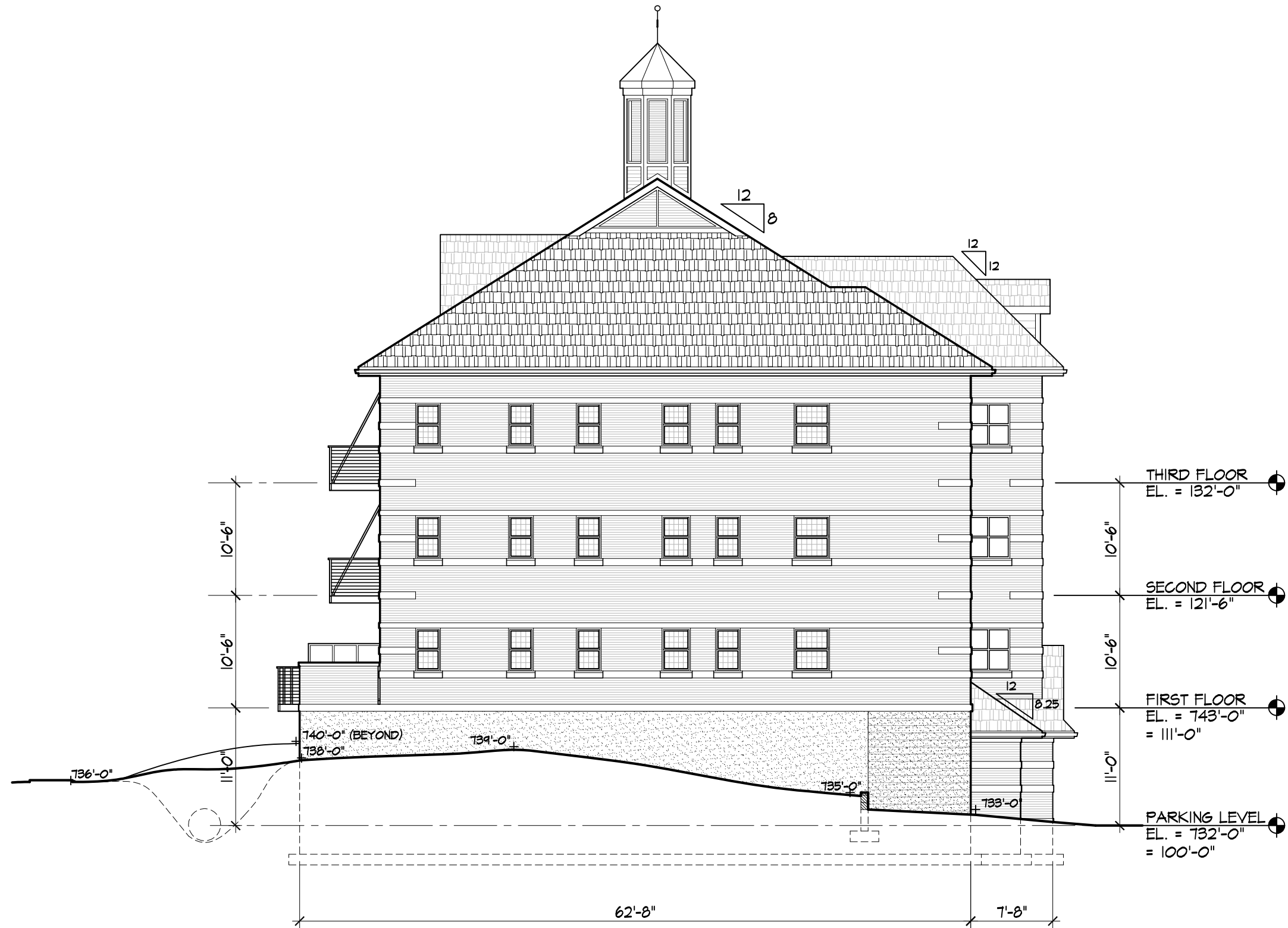

VERDANT PRAIRIES VILLAGE - VERDANT PRAIRIES PLACE APARTMENTS
SOUTH ELEVATION

SCALE: 3/32" = 1'-0" DATE 11-7-2013

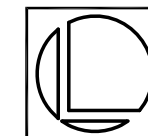

OLSEN + ASSOCIATES
 Architecture • Development • Planning
 3121 VILLAGE OFFICE PLACE • VILLAGE AT THE CROSSING
 CHAMPAIGN • ILLINOIS • 61822 • 217-369-3453

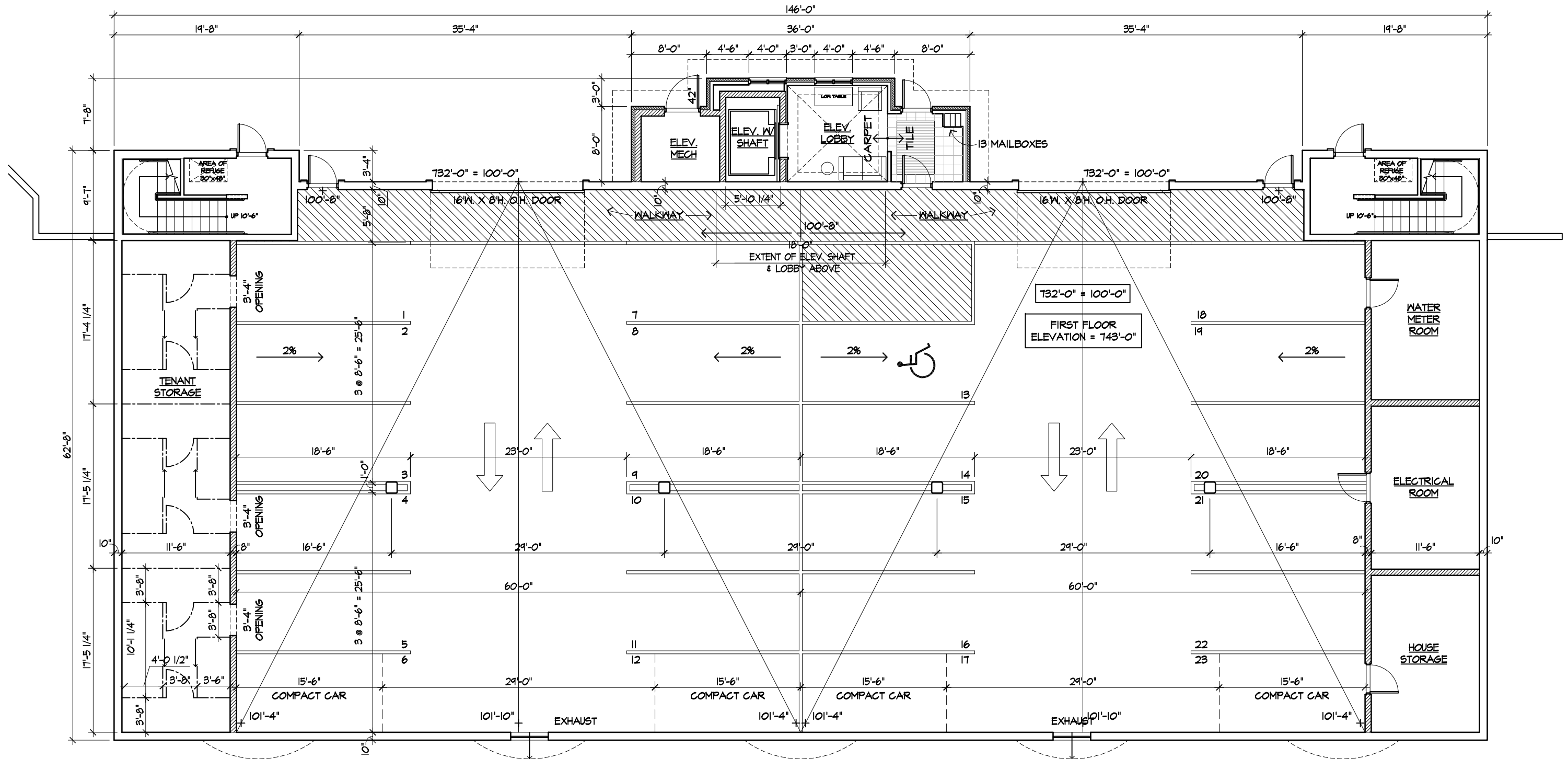

VERDANT PRAIRIES VILLAGE - VERDANT PRAIRIES PLACE APARTMENTS
GRADE PARKING LEVEL

SCALE: 3/32" = 1'-0" DATE 11-7-2013

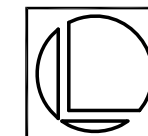

OLSEN+ASSOCIATES
 Architecture • Development • Planning
 3121 VILLAGE OFFICE PLACE • VILLAGE AT THE CROSSING
 CHAMPAIGN • ILLINOIS 61822 • 217-369-3453

ORDINANCE NO. 2012-04-035**COPY**AN ORDINANCE APPROVING A FINAL DEVELOPMENT PLAN FOR A PLANNED UNIT
DEVELOPMENT(704 E Windsor Road / Verdant Prairies Condominiums -
Plan Case No. 2172-PUD-12)

WHEREAS, Gary Olsen, on behalf of Verdant Prairies LLC, proposes to establish a residential planned unit development (PUD) for property known as 704 E Windsor Road in the R-3, Single and Two-Family Residential Zoning District; and

WHEREAS, a preliminary development plan for the proposed Verdant Prairies PUD was approved by the City Council on June 20, 2011 by Ordinance No. 2011-06-057 (Plan Case 2146-PUD-11) with the following waiver:

Maximum height for the two twelve-unit buildings as shown in the attached elevation drawing marked '3 Story 12 DU - Front (South) Elevation'.

WHEREAS, Section XIII-3 of the Urbana Zoning Ordinance requires the submission and approval of a final development plan for planned unit developments, and that all requested waivers from development standards be expressly written; and

WHEREAS, Gary Olsen, on behalf of Verdant Prairies LLC, has submitted a final development plan that is consistent with the preliminary development plan, but includes the following changes: 1) relocation of the entrances to the fourplexes; 2) the main access drive will not use permeable pavement; 3) there will be nine areas reserved for rain gardens and bioswales; 4) the two 12-unit buildings will begin at 735 feet above sea level; and 5) the access drive and the driveway median have been altered to provide better first truck access; and

WHEREAS, the final development plan includes a request for the following waiver:

Maximum height for the two twelve-unit buildings as shown in the attached elevation drawing marked 'South Elevation of West Building' with the parking level elevation at or below 735 feet above sea level (Exhibit D).

COPY

WHEREAS, after due publication, the Urbana Plan Commission on March 8, 2012 held a public hearing concerning the proposed final development plan and voted seven ayes and zero nays to forward the case to the Urbana City Council with a recommendation to approve the final development plan for the Verdant Prairies PUD with approval of one waiver; and

WHEREAS, the approval of the final development plan, with the waiver outlined herein, is consistent with the requirements of Section XIII-3 of the Urbana Zoning Ordinance, Planned Unit Developments, and with the definitions and goals of this Section of the Ordinance.

NOW, THEREFORE, BE IT ORDAINED BY THE CITY COUNCIL OF THE CITY OF URBANA, ILLINOIS, as follows:

Section 1. A final development plan for the Verdant Prairies PUD, as attached hereto in Exhibit 1, is hereby approved for property known as 704 E Windsor Road including the approval of the following waiver and conditions:

Waiver:

1. Maximum height for the two twelve-unit buildings as shown in the attached elevation drawing marked 'South Elevation of West Building' with the parking level elevation at or below 735 feet above sea level (Exhibit D).

Conditions:

1. That the petitioner work individually with adjacent property owners to determine whether they would prefer fencing or landscaping as a buffer when development adjacent to their property occurs and to install the agreed upon buffer.
2. That construction be in general conformance with the approved plans.

LEGAL DESCRIPTION:

The South 384.305 feet of the East 453.39 feet of the West 758.39 feet of the southwest Quarter of Section 21, Township 19 North, Range 9 East of the Third Principal Meridian, in Champaign County, Illinois, and a part of the Southwest Quarter of Section 21, Township 19 North, Range 9 East of the Third Principal Meridian, in Champaign County, Illinois, described as follows:

Beginning at the Northeast corner of Lot 362 in Ennis Ridge Fifteenth Subdivision, a subdivision in Champaign County, Illinois, as per plat recorded in Plat Book "U" at page 16 in the Recorder's office of Champaign County, Illinois; thence East and parallel to the North line of said Lot 362, as extended to the northwest corner of Lot 369 in said Ennis Ridge Fifteenth Subdivision; then south along the West line of Lot 369, 370 and 371 in said Ennis Ridge Fifteenth Subdivision to the Northeast corner of the Windsor Swim club Co. property, as per deed

COPY

recorded in Book 807 at page 208 as document no. 738389 in the Recorder's office of Champaign County, Illinois; thence West along the North line of said Windsor Swim Club Co. property to the East line of Lot 360 in Ennis Ridge fifteenth Subdivision, thence North along the East line of said Lot 360, and East line of Lots 361 and 362 in Ennis Ridge Fifteenth Subdivision, to the place of beginning, in Champaign County, Illinois, EXCEPT the following described real estate:

Beginning at a steel pipe monument at the Northeast corner of Lot 362 of Ennis Ridge Fifteenth Subdivision; thence on a local bearing North 89°30'30" East, along the South right-of-way of Scovill Street in the City of Urbana, Illinois, 453.38 feet to an iron pipe set in concrete at the northwest corner of Lot 369 of said Subdivision; thence South 0°43'20" East, along a Westerly line of said Subdivision, 130.00 feet to a steel rod marker; thence South 89°30'30" West, 453.38 feet to a steel rod marker located on an Easterly line of said Subdivision; thence North 0°43'20" West, along said Easterly line, 130.0 feet to a point of beginning, in Champaign County, Illinois.

Permanent Parcel No.: 93-21-21-357-024

Section 2. The City Clerk is directed to publish this Ordinance in pamphlet form by authority of the Corporate Authorities. This Ordinance shall be in full force and effect from and after its passage and publication in accordance with the terms of Chapter 65, Section 1-2-4 of the Illinois Compiled Statutes (65 ILCS 5/1-2-4).

PASSED by the City Council this 2nd day of April, 2012.

AYES: Bowersox, Jakobsson, Lewis, Marlin, Roberts, Smyth

NAYS:

ABSTAINS:

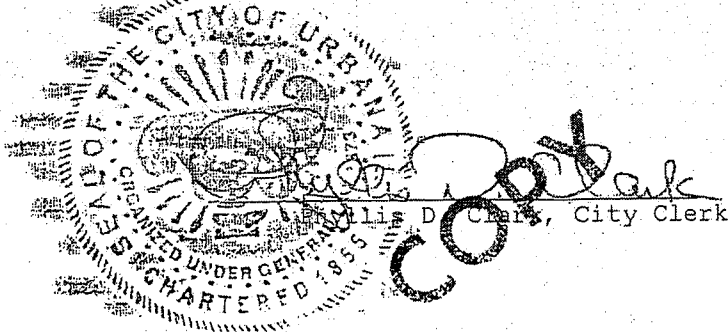

APPROVED by the Mayor this 4th day of April, 2012.

Laurel Lunt Prussing
Laurel Lunt Prussing, Mayor



CONSTRUCTION PHASES

PHASE ONE

22 DWELLING UNITS + CLUBHOUSE
 PRIVATE ROADWAY & DRIVEWAYS
 UTILITY INFRASTRUCTURE
 SOUTH & WEST SIDE PATH & WALKWAYS

PHASE TWO

22 DWELLING UNITS
 PRIVATE DRIVEWAYS
 EXTEND WALKING PATH TO NORTH & EAST

PHASE THREE

'A' - ADD 4 DWELLING UNITS + ENHANCEMENTS TO CLUBHOUSE
 'B' - 0 UNITS + COVERED (5) LANE LAP POOL + ENHANCEMENTS TO CLUBHOUSE
 'C' - DO NOTHING (LEAVE GRASSY FIELD W/ PERIMETER TREES)

PARKING CRITERIA

DEDICATED PARKING

BLDG	ENCLOSED	OPEN
A	23, 1 HA	22, 3 HA
B	8	8
C	8	8
D	8	8
E	8	8
F	23, 1 HA	2, 1 HA
G	8	8
TOTAL	86, 2 HA	64, 4 HA

TOTAL SITE ACREAGE:
 4.01 ACRES

BUILDING FOOTPRINT TOTAL:
 1.27 ACRES

TOTAL PAVED SURFACE AREA (EXCLUDING PERIMETER TRACK):
 1.05 ACRES

LINEAR LENGTH OF PERIMETER TRACK:
 .388 MILES



VERDANT PRAIRIES CONDOMINIUMS
SITE PLAN

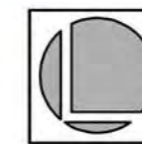
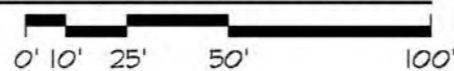

OLSEN+ASSOCIATES
 Architecture ■ Development ■ Planning
 3121 VILLAGE OFFICE PLACE ■ VILLAGE AT THE CROSSING
 CHAMPAIGN ■ ILLINOIS ■ 61822 ■ 217-359-3453

TABLE XIII-2. PLANNED UNIT DEVELOPMENT RECOMMENDED DESIGN FEATURES

General Site Design	Recommended Design Feature	Applicable PUD Type
Building Layout	Buildings should be placed in a manner that facilitates the recommended design features of this Article.	All
Transition Area	The development shall incorporate general design features from the surrounding area, including street design, building configuration, landscaping and setbacks, to ensure compatibility and to provide a transition between differing land use intensities.	All
Lighting	Lighting design, amount, angles, and placement should reduce excessive lighting and minimize negative impacts on nearby residential areas.	All
Street Lights	Street lighting approved by the City Engineer should be provided to enhance public safety and visibility.	All
Pedestrian Connectivity		
Crosswalks	Crosswalks through intersections of sidewalks and streets should be designed with clearly defined edges, either by contrasting paving materials or striping.	All
Connectivity	All pedestrian facilities should connect to on-street and off-street bicycle facilities, existing and planned bicycle and shared-use paths identified in the <i>Champaign County Greenways and Trails Plan</i> , the Urbana Capital Improvements Plan, and the Comprehensive Plan.	All
Transit	Adequate space for well-lit transit shelters should be provided to clearly identify bus stops. Curb cuts, bump outs, and other infrastructure should be provided as necessary to facilitate transit provision.	All
Internal Connectivity	A network of sidewalks, bicycle paths and trails should be included in a development to link buildings within a site and to the surrounding neighborhood.	All
Bicycle Parking	Bicycle racks should be placed convenient to building entrances, and under canopies whenever possible. The minimum amount of bicycle parking required is stipulated in Table VIII-1, and should be increased when necessary.	All

Vehicular Connectivity	Recommended Design Feature	Applicable PUD Type
Access	Roads and Access drives that connect to major roads should be spaced in accordance with the <i>Champaign County Access Management Guidelines</i> . The number of access points drives shall be minimized, and all access points are subject to approval by the City Engineer.	All
Internal Connectivity	The internal street system of a development should promote efficient traffic movement and be generally consistent with the goals and objectives of the 2005 Urbana Comprehensive Plan.	All
External Connectivity	The internal street system of a development should connect to adjacent roadways to promote an efficient citywide transportation system consistent with the Mobility Map of the 2005 Urbana Comprehensive Plan.	All
Parking Areas		
Permeable Parking	Where appropriate and feasible, parking areas should utilize permeable materials to minimize stormwater runoff. Any such material is subject to approval by the City Engineer.	All
Maximum Parking	The amount of parking provided should be reduced to the minimum amount required by the use, as identified in Table VIII-3, or by additional data related to parking demand.	All
Rear Parking	Parking areas should be located behind the principal structure whenever possible to encourage a more pedestrian-friendly environment.	Commercial Mixed Use Industrial
Parking Area Landscaping	The corners of parking lots, tree islands, and all other areas not used for parking or vehicular circulation should be landscaped. Vegetation can include turf grass, native grasses or other perennial flowering plants, vines, shrubs, or trees. Such spaces may include architectural features such as benches, kiosks or bicycle parking	Commercial Mixed Use Industrial
Shared Parking	Design parking lots to take advantage of potential sharing among nearby commercial, office, residential, and industrial uses with differing operating hours and peak parking demand times in order to minimize the amount of parking area.	All

Landscaping and Screening	Recommended Design Feature	Applicable PUD Type
Landscape Identity	Distinct landscaping, such as prairie plantings or large caliper trees, should be used to link signage, pedestrian facilities, parking areas, drainage areas, and buildings together in order to distinguish the site. A listing of approved materials is provided in Table VI-1 and Table VI-2. Additional materials may be approved by the City Arborist.	All
Tree Preservation	Significant trees, as identified by the City Arborist, should be protected and incorporated into the development to the greatest extent possible.	All
Street Trees	Deciduous canopy street trees shall be provided along all streets in a development. Trees need not be evenly spaced, and should be placed in the landscaped area of a boulevard, or in tree wells.	All
Screening	Screening shall be required in accordance with Section VI-6 and Section VIII-3.F.	All
Open Space		
Open Space Provision	Open space uses, such as environmental corridors, protected natural areas, community parks, water bodies, and stormwater facilities, should be either retained or created and incorporated into the development plan as appropriate, and in accordance with the Comprehensive Plan.	All
Open Space Purpose	Open space uses should protect significant natural, cultural, and historical resources such as wooded and other natural areas, natural detention areas, vistas, drainage ways, and historic structures or properties.	All
Greenways and Trails	Provide connections to existing and planned bicycle, shared-use paths, and greenways identified in the <i>Champaign County Greenways and Trails Plan</i> , the Capital Improvements Plan, and the Comprehensive Plan.	Residential Commercial Mixed Use
Drainage Areas	Drainage areas may count as open space, but should not constitute the majority of open space. Drainage areas should be permanently accessible to the public and link to other such areas within a development.	All
Passive Recreation	Provide passive recreation areas that appeal to a wide demographic, such as off-street nature trails, sculpture gardens, community garden plots, and covered picnic areas, where appropriate in the development.	Residential Commercial Mixed Use

Open Space	Recommended Design Feature	Applicable PUD Type
Active Recreation	Provide areas for active recreation that appeal to a wide demographic, such as play lots and sports fields, where appropriate in the development.	Residential Commercial Mixed Use
Connected Open Space	Open space throughout the development should be linked by sidewalks, trails, or across public right-of-way in order to avoid separate isolated open space areas.	All
Architectural Design		
Architectural Consistency	Incorporate common patterns and architectural characteristics found throughout the development and the surrounding area, such as porches, roof types, and building massing.	Residential Commercial Mixed Use
Architectural Identity	Utilize a number of architectural features, landscaping, public art, and other methods to ensure buildings create an identity for the development.	Residential Commercial Mixed Use
Articulated Design	Buildings should look "complex and engaging," including varying roof heights and pitches, forward and back progressions, exterior trim details, outdoor living space and other decorative details and exterior materials.	Residential Commercial Mixed Use
Openings	Windows, doors and other openings should be in scale and proportionate with each other. Openings should display a consistent pattern and rhythm in order to "break up" large wall spaces.	Residential Commercial Mixed Use
Exterior Surfaces	Exterior treatment, such as brick, or siding should protect the integrity of the structure and provide an enhanced visual aesthetic to the block.	Residential Commercial Mixed Use
Fences	Walls and fences should be compatible with the architecture of the site and surrounding properties.	All
Building-Street Relationship	The principal entrance of a building should be oriented towards the street. Porches, pent roofs, roof overhangs, hooded front doors or other similar architectural elements should be used to define the principal entrance of a building.	Residential Commercial Mixed Use

Architectural Design	Recommended Design Feature	Applicable PUD Type
Garages	Garages may be located within the principal building or as an accessory building provided that the accessory building conforms to Section V-2. When possible, garages should be accessed from behind the front façade of a building.	Residential Mixed Use
Energy Efficient Construction	Whenever possible, a development should utilize building construction and site design that incorporate innovative and effective techniques in energy conservation. A development that achieves at least enough points to attain LEED "Certified" status is highly recommended.	All
Materials	Utilize exterior treatments or siding that protect the integrity of a structure and provide an enhanced visual aesthetic for the development consistent with other architectural features.	Residential Commercial Mixed Use
Accessibility / Visitability	Individual buildings should incorporate design features that encourage accessibility and visitability, such as wide doorways, bathrooms on the main floor, and "zero step" entryways.	All
Signage		
General Signage	The amount and type of signage in a development should be architecturally compatible with the building design and development in general, including materials, scale, colors, lighting and general character in order to promote better recognition of a specific business.	Commercial Mixed Use Industrial
Freestanding Signs	Freestanding signs should incorporate design elements, such as landscaping, strategic placement, and compatible materials, to draw attention. Monument signage (as opposed to pylon signs) is strongly encouraged when appropriate, especially near residential areas.	Commercial Mixed Use Industrial
Group Signage	Multiple businesses or shopping centers shall group signage near main access drives and utilize landscaping or other means to visually link signs to the site and building.	Commercial Mixed Use Industrial